

ADCOM

OWNER'S MANUAL

GTP-880



Digital Processing Tuner/Preamplifier

WELCOME

Dear fellow ADCOM product owner,

Welcome to the ADCOM family! For more than twenty years, ADCOM products have delivered excellent performance and value for customers around the world. Our products are designed by our experienced and demanding engineering team, built to the highest standards in our factory, and sold and serviced through dealers, custom installers, and other retailers whose primary goal is your complete satisfaction.

We know you are anxious to hear your new preamplifier in action, but please take a few minutes to read this owner's manual before connecting the preamplifier to your system. It is particularly important that you connect your preamplifier to your amplifier while the amplifier and preamplifier are unplugged and your other equipment is turned off. This will protect your equipment from potential short circuits that may occur during installation. In addition, it is important that you allow for adequate ventilation around your preamplifier and other equipment, since excessive heat buildup can shorten the life of any electronic product, including the preamplifier. Once you have correctly connected your new preamplifier to your other components, you should be able to enjoy many trouble-free years of performance.

We conduct a thorough quality and performance test on each and every preamplifier we build in our factory prior to shipment. In the rare case of a defect that may occur after shipment, we stand behind our preamplifiers with a five-year parts and labor warranty. To register for this warranty, please complete and mail the enclosed warranty card back to ADCOM. Also, please keep a copy of your sales receipt with the owner's manual so you may provide proof of eligibility for the warranty should the need arise.

We know you will be very happy with the sound and performance of your new preamplifier. We hope you will also consider other ADCOM products, such as our line of multichannel amplifiers and DVD players. In addition, we design and manufacture complementary products such as surge suppressors and speaker selectors. Please visit our web site at www.adcom.com to learn more about our complete line of stereo, home theater, and distributed audio/video products.

On behalf of all of us at ADCOM, I want to thank you for selecting our product for your home or business entertainment system.

Sincerely,



Douglas Klein
President
ADCOM
A division of
Klein Technology Group, LLC

Welcome	2
Table of Contents	3
Safety Information	4
Unpacking your GTP-880	5
Warranty Information	5
Description of Unit	
1.1 Front Panel Illustration	6
1.2 Introduction to the GTP-880	6
1.3 Interface Overview	6-9
1.4 Surround Formats	9-10
1.5 Rear Panel Illustration	12
1.6 Input & Output System Connections	13-15
1.7 Connecting Components	15-23
Remote Control	
2.1 Remote Control Illustration	24
2.2 Overview of the GRC-810	25
2.3 Remote Features	25-26
2.4 Remote Function Table	26-31
2.5 Programming the ADCOM GRC-810	32-33
2.6 Programming Macro Buttons	33
2.7 Function and Data List (Discrete)	34-35
Setup	
3.1 Setup Overview	36
3.2 On Screen Display	36
3.3 Input Configuration	36-37
3.4 Speaker Configuration	37-39
3.5 Channel Configuration	39-41
Channel Calibration	
Channel Trim	
3.6 Delay Configuration	41-42
3.7 System Configurations	42-43
3.8 Prologic II and Neo:6 Music Config	43-44
3.9 Room Two Configuration	44-45
3.10 Additional Options	45-46
Resolving Problems	48
Trouble Shooting	49
Caring for your GTP-880	50
Service Information	50
GTP-880 Specifications	51

THE FOLLOWING PRECAUTIONS AND SAFETY INSTRUCTIONS ARE REQUIREMENTS OF UL AND CSA SAFETY REGULATIONS

Warning: To reduce the risk of fire or electric shock, do not expose this unit to rain or moisture.

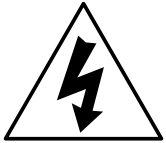
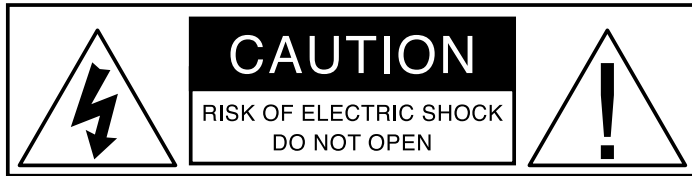

The graphic symbol of a lightning flash with an arrow point within a triangle signifies that there is dangerous voltage within the unit and it poses a hazard to anyone removing the cover to gain access to the interior of the unit. ONLY qualified service personnel should make any such attempt.



The graphic symbol of an exclamation point within an equilateral triangle warns a user of the device that it is necessary to refer to the instruction manual and its warnings for proper operation of the unit.

Do not place this unit on an unstable cart, stand, tripod, bracket, or table. The unit may fall, causing serious injury to a child or adult, and serious damage to the unit. Use only with a cart, stand, tripod, bracket, or table recommended by the manufacturer or sold with the unit. Any mounting of the device should follow the manufacturer's instructions, and should use a mounting accessory recommended by the manufacturer.

Read all the safety and operating instructions before connecting or using this unit.

Retain this notice and the owner's manual for future reference.

All warnings on the unit and in its operating instructions should be adhered to.

All operating and use instructions should be followed.

Do not use this unit near water. For example, near a bathtub, washbowl, kitchen sink, laundry tub, in a wet basement, or near a swimming pool.

The unit should be installed so that its location or position does not interfere with its proper ventilation. For example, it should not be situated on a bed, sofa, rug, or similar surface that may block the ventilation openings; or placed in a built-in installation, such as bookcase or cabinet, that may impede the flow of air through its ventilation openings.

The unit should be situated away from heat sources such as radiators, heat registers, stoves, or other devices (including amplifiers) that produce heat.

The unit should be connected to a power supply outlet only of the voltage and frequency marked on its rear panel.

The power supply cord should be routed so that it is not likely to be walked on or pinched, especially near the plug, convenience receptacles, or where the cord exits from the unit.

Clean unit only as recommended in its instruction manual.

The power supply cord of the unit should be unplugged from the wall outlet when it is to be unused for a long period of time.

Care should be taken so that objects do not fall, and liquids are not spilled, into the enclosure through any openings.

This unit should be serviced by qualified service personnel when:

- A. The power cord or the plug has been damaged; or
- B. Objects have fallen, or liquid has been spilled, into the unit; or
- C. The unit has been exposed to rain, or liquids of any kind; or
- D. The unit does not appear to operate normally, or exhibits a marked change in performance; or
- E. The device has been dropped, or the enclosure damaged.

**DO NOT ATTEMPT SERVICING OF THIS UNIT YOURSELF.
REFER SERVICING TO QUALIFIED SERVICE PERSONNEL.**

ATTENTION

POUR PREVENIR LES CHOCS ELECTRIQUES NE PAS UTILISER CETTE FICHE POLARISEE AVEC UN PROLONGATEUR, UNE PRISE CE COURANT OU UNE AUTRE SORTIE CE COURANT, SAUF SI LES LAMES PEUVENT ETRE INSEREES A FOND SANS EN LAISSER AUCUNE PARTIE A DECOUVERT.

CAUTION

TO PREVENT ELECTRIC SHOCK DO NOT USE THIS POLARIZED PLUG WITH AN EXTENSION CORD, RECEPTACLE OR OTHER OUTLET UNLESS THE BLADES CAN BE FULLY INSERTED TO PREVENT BLADE EXPOSURE.

CAUTION POWER LINES

Any outdoor antenna must be located away from all power lines.

OUTDOOR ANTENNA GROUNDING

If an outside antenna is connected to your tuner or tuner/preamplifier, be sure the antenna system is grounded so as to provide some protection against voltage surges and built-up static charges. Section 810 of the National Electrical Code, ANSI/NFPA No. 701984, provides information with respect to proper grounding of the mast and supporting structure, grounding of the lead-in wire to an antenna discharge unit, size of grounding conductors, location of antenna discharge unit, connection to grounding electrodes, and requirements for the grounding electrode.

- a. Use No.10 AWG (5.3 mm²) copper, No.8 AWG (8.4 mm²) aluminum, No.17 AWG (1.0 mm²) copper clad steel or bronze wire, or larger, as a ground wire.
- b. Secure antenna lead-in and ground wires to house with stand-off insulators spaced from 46 feet (1.221.83 m) apart.
- c. Mount antenna discharge unit as close as possible to where lead-in enters house.
- d. Use jumper wire not smaller than No.6 AWG (13.3 mm²) copper, or the equivalent, when a separate antenna grounding electrode is used. See NEC Section 810-21 (j).

EXAMPLE OF ANTENNA GROUNDING AS PER NATIONAL ELECTRICAL CODE INSTRUCTIONS CONTAINED IN ARTICLE 810. RADIO AND TELEVISION EQUIPMENT.

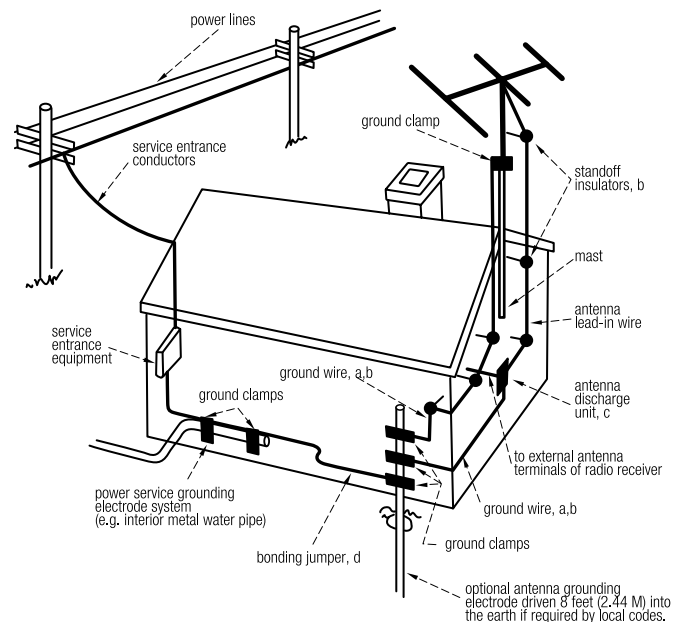

NOTE TO CATV SYSTEM INSTALLER

This reminder is provided to call the CATV system installer's attention to Article 82022 of the National Electrical Code that provides guidelines for proper grounding and, in particular, specifies that the cable ground shall be connected to the grounding system of the building, as close to the point of cable entry as practical.

Unpacking the GTP-880

Before your new ADCOM tuner-preamplifier left our factory, it was carefully inspected for physical imperfections and tested for all electrical parameters as a routine part of ADCOM's systematic quality control. This, along with full operational and mechanical testing, should ensure a product flawless in both appearance and performance. After you have unpacked the GTP-880, inspect it for physical damage. Save the shipping carton and all packing material as they are intended to reduce the possibility of transportation damage should the preamplifier ever need to be shipped again. In the unlikely event damage has occurred, notify your dealer immediately and request the name of the carrier so a written claim to cover shipping damages can be initiated. The right to a claim against a public carrier can be forfeited if the carrier is not notified promptly in writing and if the shipping carton and packing materials are not available for inspection by the carrier. Save all packing materials until the claim has been settled.

ADCOM Protection Plan (USA only)

ADCOM offers the enclosed valuable limited warranty. Please read the details on the warranty card carefully to understand the extent of the protection offered by the warranty, its reasonable limitations, and what you should do in order to obtain its benefits. Be sure to verify that the serial number printed on the rear panel matches the serial number on the outer carton. If any number is altered or missing, or if the ADCOM warranty card is not included in the carton, you should notify us immediately in order to ensure that you have received a genuine ADCOM product which has not been opened, mishandled, or tampered with in any way. **Always retain your original sales receipt as a proof of purchase.**

This unit is manufactured under license from Dolby Laboratories Licensing Corporation. It is additionally licensed under one or more of the following patents: U.S. number 3,959,880, Canadian numbers 1,004,603 and 1,037,877. Dolby® Pro Logic®, Dolby ProLogic II®, Dolby Digital EX®, and Dolby Digital® are registered trademarks of Dolby Laboratories Licensing Corporation.

Manufactured under license from Digital Theater Systems, Inc. US Patent Number 5,451,942 and other world-wide patents issued and pending. "DTS®," "dts®," "DTS Digital Surround®," "DTS-ES®," "DTS NEO:6®" are trademarks of Digital Theater Systems, Inc. Copyright 2003 Digital Theater Systems, Inc. All Rights Reserved.



1.1 Front Panel Illustration



- | | | |
|--------------------------|----------------------------|-------------------------|
| [1] Standby Power Button | [4] Analog Direct Select | [7] Source Selections |
| [2] Room Two Control | [5] Digital Tuner Controls | [8] Volume Control Knob |
| [3] Bass & Treble | [6] Front Panel Display | [9] Surround Mode |

1.2 Introduction to the GTP-880

Congratulations on your decision to purchase the ADCOM GTP-880 tuner-preamplifier. The GTP-880 provides Dolby Digital and DTS decoding with 7.1 output channels and the RDS (Radio Data System) tuner. You have made a wise choice that will reward you for years to come with exceptionally accurate and musical sound reproduction. To realize the full potential of your new preamplifier, and before making any connections to it, please read these operating and installation instructions thoroughly.

1.3 Interface Overview

The GTP-880's front panel is designed for ease of operation. All controls are logically grouped for easy, intuitive operation. Familiarize yourself with the preceding diagram and read the short explanations of each feature below. When you finish, you will be well on your way to enjoying the GTP-880's convenience and sound quality.

[1] Standby Power Button

Pressing this button turns the unit on, indicator is red. Pressing this button again returns the GTP-880 to standby mode. The standby indicator is amber.

In this mode of operation, the front panel display is turned off, control functions are disabled, and all outputs to the main room are turned off. Outputs to room two remain active and available. It should be noted that they are only "active" if room two power is on.

Note: The rear panel power switch must be on for this button to function.

[2] Room Two Control

The GTP-880 has the ability to play and control an analog audio signal in a second room from the front panel or remote control. Any of the incoming analog audio signals can be distributed to the second room, with the exception of analog direct inputs.

On/Off Button: Pressing this button activates the room two functionality and control. The on/off indicator light illuminates.

Note: This light will remain lit when the other indicators are off, as long as the second room is active.

Pressing this button again turns room two off, indicator light extinguishes.

Setup Button: Pressing this button enters the room two setup mode, pressing this button again will cycle a list of room two options. Use the volume control knob to make selections while in setup.

After entering setup the first option presented turns room two off or on. Pressing this button again gives the option to select a source to be played in room two.

Pressing this button again presents the option to mute the output in room two.

Pressing this button again presents the option to set the listening volume in room two, range is -80dB to 10dB.

Note: If no other selection is made while in setup, selections will be saved and configuration will exit within 5 seconds.

[3] Bass & Treble Adjustments

These buttons control bass and treble equalization. Adjustments are made in 2dB steps.

Bass Button: Pressing this button displays current bass setting, range is from -8dB to +8dB. Use the volume knob to make an adjustment.

Treble Button: Pressing this button displays current treble setting, range is from -8dB to +8dB. Use the volume knob to make an adjustment.

Bypass Button: Defeats the tone controls and provides an unaltered, full-bandwidth stereo signal to the left and right channel outputs on the rear panel. However, the subwoofer DSP crossover remains active and bass frequencies are available at the subwoofer output should you wish to augment your front L/R speaker's low frequency performance. The word "bypass" appears in the front panel display. Pressing the button again returns the unit to the previously selected tone settings.

[4] Analog Direct Selections

These buttons select audio inputs from analog multichannel sources such as DVD Audio or SACD players. The 2 channel button bypasses the DSP processing for the main selected input. Bypass 2 Channel mode provides straight two channel listening. This mode is only applicable with an analog source, as this input signal bypasses all processing sending a full-range signal to the front Left and Right channels. However, if the user has set Subwoofer to be on in the system setup, a Low Pass Filtered matched signal to the crossover frequency set for the front left and right channels will be sent to the subwoofer in order to help reinforce the low-frequency response of the system. If the user truly has full-range speakers (20Hz-20kHz) and does not desire to have this bass reinforcement signal, the user need only disable the subwoofer in the system setup or in their system.

[5] Digital Tuner Controls

FM/AM Button: Toggles between AM and FM frequency bands.

FM Mode Button: Sets the FM tuner to mono mode. The letter "M" appears next to the tuner preset number in the front panel display. Pressing the button again returns the

FM tuner to stereo mode.

The letter "S" will appear ONLY when a stereo station has been locked by the Digital Tuner. A flashing "S" indicates that the particular chosen station signal strength is not strong enough for the Digital Tuner to "lock" onto the stereo signal. In this instance, the user may want to consider placing the tuner into mono mode.

Memory Button: Pressing this button when FM or AM is selected as the input source memorizes the current station frequency into one of the presets. You can preset up to 32 stations.

Tuner Up/Down Buttons: The function of these buttons depends on the tuning mode selected with the tune/preset button.

In preset mode (indicated in the display area): Press the down button to scroll to a lower number preset; press the up button to scroll to a higher preset number. This is a "wrap-around" function, so that going from the highest number preset, the tuner will go to the lowest preset number or vice-versa when tuning either up or down.

In tune mode: Press the up or down button for more than 1/2 second to engage automatic tuning respectively up or down the frequency band. The tuner will search automatically for the first reasonably strong radio station, where it will stop. Press the down/up button again for 1/2 second to start searching again.

The GTP-880 tuner can receive AM, FM and FM stereo broadcasts. Up to 32 stations can be preset and accessed from the front panel or remote. Stations can also be tuned manually.

Note: Tuner reception cannot take place unless an appropriate AM and/or FM antenna is connected to the rear panel of the GTP-880.

To operate the tuner:

1. Press the tuner button on the remote control once, or press the tuner button on the front panel.

This indicates that the tuner is in FM, with stereo selected as the surround mode. The number displayed next to the tuner text is the preset number currently selected or last selected, followed by the stereo reception indicator if the station is being received in stereo. The numbers next to the FM text are the frequency of the selected preset or station. The numbers in front of the dB indication are the current volume setting.

2. Press the AM/FM button on the remote control or the front panel to change between AM and FM bands.

This display indicates that the tuner is in AM with a selected preset and the frequency of that preset or station. The numbers in front of the dB indication are the current volume setting.

3. Use the tune buttons on the front panel or the remote to change the tuner frequency. The new frequency will be displayed to the left of the volume level on the front panel display and OSD.

Pressing a tune button once increases or decreases the FM frequency by .1 MHz and the AM frequency by 10 KHz.

4. Press and hold either the of the tune buttons on the front panel or the remote to scan continuously up or down the selected band. The tuner will stop on the next available station when you release the button.

5. Press the FM mode button on the front panel to toggle between stereo and mono.

If an FM station produces lots of noise or sound that cuts in and out while in stereo, use this control to change the FM mode from stereo to mono.

If you select mono as the operating mode an indicator will appear next to the preset number.

To preset a radio station into memory:

1. Tune to the radio station you desire.
2. Press and hold the mem button on the remote or the memory button on the front panel to store a station into a preset location. The display will change to show the word "memory" along with a flashing number.
3. Quickly enter the desired preset/memory location (01 through 32) using the numeric keypad on the remote. This programs the radio station to that memory location. You have approximately five seconds to enter a number.

Up to 32 stations can be stored, randomly between AM and FM, in memory as presets.

To tune to a radio station that you have preset:

1. Set the GTP-880 to tuner.
2. Use the numeric keypad on the remote control to enter the two digit number of the preset that you want to hear.

The tuner frequency (and band if it is different then the previously tuned station) changes to the new station in the preset memory of the GTP-880.

To change a preset radio station:

1. Tune to the new radio station you desire.
2. Press and hold the mem button on the remote or the memory button on the front panel. The display will change to show the word "memory" along with a flashing number.
3. Quickly enter the new preset/memory location (01 through 32) using the numeric keypad on the remote. This replaces the previously memorized preset with your new selection. You have approximately five seconds to enter a number.

[6] Front Panel Display

Indicates program source, DSP mode, tuner preset and/or frequency, digital input, volume level, and other GTP-880/tuner operating information. Also displays menu selections. Diming of the display may be accomplished via the remote control or through the on screen display.

The front panel display provides visual feedback of the current settings, surround modes and configuration menus of the unit. Information is constantly displayed at the front panel whenever the GTP-880 is turned on.

The information presented on the front panel is identical to that shown on your TV monitor via the on screen display, allowing you to perform speaker settings, set up your input sources, set the listening modes, and much more.

[7] Source Buttons

These buttons select the active video and audio input for the GTP-880. The source that is currently selected will be shown in the front panel display and the LED in the source button will be red.

DVD, Video 1, Video 2, Video 3, VCR, AUX, CD, Tape

Tuner: Pressing this button changes the source to the built-in AM/FM digital tuner. Please refer to digital tuner controls, previously detailed in this section for more instructions on using the GTP-880's tuner.

[8] Volume control

The volume control adjusts the overall loudness of the signals being fed to the preamplifier outputs. Unlike conventional controls, the GTP-880's volume control doesn't have a start or end position. Volume can also be adjusted from the remote control using the master volume up or down buttons. The volume control does not affect recordings made using the tape or VCR outputs but will affect the signal going to the preamp outputs. The volume level is indicated in the display panel when it is being adjusted,

and after three seconds the display defaults to its previous status. Volume setting can range from -80dB to +10dB.

On the remote control, press the mute button to temporarily switch off the sound to the preamp outputs. Mute mode is indicated by the word "mute" in the display area. Press mute again or adjusting the volume will restore sound. Mute does not affect recordings made using the tape or VCR outputs but does affect the signal going to the preamp outputs.

Adjusts the volume level for the main room only. Room two is not affected by this control.

[9] Surround Mode Buttons

With the surround mode buttons the available surround sound modes can be selected. The selected surround mode is permanently indicated in the display area and is also shown for three seconds in the large text section of the display.

7.1m²™ Button: Pressing this button activates ADCOM's proprietary decoding algorithm.

This proprietary analog-domain post-processing technique takes 5.1 channel or other sources that have surround channel information and extracts a pseudo-stereo surround back channel information. Only DSP modes that do NOT generate more than 2 surround channels (e.g. - Dolby Digital, DTS, 5 Stereo, Dolby Pro Logic, Dolby Pro Logic II Cinema, Dolby Pro Logic II Music, DVD-Audio Bypass Input, SACD Bypass Input) can benefit from ADCOM 7.1m² post-processing. Trying to enable ADCOM 7.1m² during any other DSP mode (e.g. Dolby Digital EX, DTS-ES Extended Surround, 7 Stereo, 2 Channel Bypass) is Invalid and will be indicated as such by the system. Additionally if the system setup does NOT indicate that the system setup offers 2 surround back channels, ADCOM 7.1m² will never be offered as option.

Pressing this button again turns 7.1m²™ decoding off and returns to previously selected surround mode.

Select Left/Right Button: Pressing this button cycles through list of available surround modes.

1.4 Surround Format Information

The GTP-880 provides decoding for Dolby Pro Logic® II, Dolby Digital® 5.1, Dolby Digital EX®, DTS®, DTS-ES® Discrete, DTS-ES® Matrix, DTS NEO:6® and ADCOM 7.1m²™. Within each mode, the GTP-880 also offers a wide range of additional processing options. This means you can precisely match a surround mode to your program mate-

rial, loudspeaker setup and personal taste. In addition, the GTP-880 precision bass management feature provides maximum flexibility when setting up your audio surround system (see "system setup" for further details).

ADCOM 7.1m²™: ADCOM's proprietary decoding algorithm. The 7.1m²™ decoding process mixes the signals from the left surround and right surround channels to derive two unique signals sent to each back output. The benefit of our 7.1m²™ decoding process is enhance imaging between the surround speakers and the creation of a more diffuse ambient sound field. The 7.1m²™ process has the same benefits when compared to other matrix decoding as stereo signals have over mono signals. The 7.1m²™ process can also be used to drive your surround back speakers when you are listening to an externally decoded DVD audio or SACD multichannel disc. Due to the varying nature of film soundtracks and music, you may prefer to activate or deactivate the surround back channels. For example, Dolby Digital 5.1 and DTS soundtracks benefit greatly from the addition of the 7.1m²™ processing. ProLogic soundtracks on the other hand provide a mono surround signal track, which yields a less satisfying experience when using the surround back channels.

Note: 7.1m² decoding may only be applied to 5 channel signals.

Dolby Digital: This digital audio format provides 5.1-channel surround sound. Dolby Digital source material includes DVDs, laser discs, HDTV broadcasts, some satellite delivered programming, and the output of some digital cable set top boxes.

Dolby Digital Surround EX: This processing mode is a joint development of Dolby Laboratories and the THX division of LucasFilm, Ltd. Film soundtracks encoded with Dolby Digital Surround EX technology contain an extra channel, added to the soundtrack during mixing, called surround back, which places audio behind the listener in addition to the existing front left, front center, front right, surround left, surround right, and subwoofer channels. This additional channel provides more detailed imaging behind the listener creating more depth, spacious ambience and sound localization than before.

Note: Surround EX mode can also be engaged during the playback of 5.1 channel material that is not Dolby Digital Surround EX encoded. When used this way, signals from the left and right surrounds are used to synthesize the surround back channel. Results using this method will vary

depending on the source material.

Surround EX decoding is ONLY applicable to 2/2.0, 2/2/.1, 3/2.0, 3/2.1 streams AND when there is one or two surround back channels available in the system.

Dolby Pro Logic II: Dolby Pro Logic II is a substantial enhancement to the original Pro-Logic process. In addition to full-bandwidth surrounds, Pro Logic II provides three unique user adjustable processing options: panorama; dimension; and center width. Used primarily in Pro Logic.

Dolby Pro Logic II-C (Cinema): This processing mode can create up to 6 full bandwidth channels from any stereo, 2 channel source, idea for use with movies.

Dolby Pro Logic II-M (Music): In music mode there are three additional adjustments.

Panorama provides an extension of the front stereo image to the surround channels creating an enveloping, wrap-around effect.

Dimension enables adjustment of the surround image between the front and rear of your room. Certain types of music benefit from smoother overall balance and a more natural sounding image.

Center width provides variable adjustment of the center channel image and location, to create a more seamless front soundstage as well as control of the sense of "width" across the L/C/R loudspeaker array. A phantom center image can also be created from just the left and right front speakers.

DTS: This compressed digital data format is similar to Dolby Digital. DTS also provides 5.1 channel surround channels and is available on compact disc, DVD and laser discs. Audio-only DTS discs may be used with any CD, LD or DVD player with a digital audio output, but DVD discs with DTS audio must be used on players with the "DTS Digital Out" logo.

DTS-ES: An extension of the original DTS format that adds an additional sixth, or center surround, channel to a soundtrack. DTS-ES Matrix 6.1 titles provide a surround back channel by a matrix decoding process, while DTS-ES Discrete 6.1 media deliver a true discrete center surround channel. Both DTS-ES formats are backwards compatible with the original DTS process, and will deliver a 5.1 channel output when no center or back surround speakers are available. Additionally, the user may force the system to decode a DTS-ES Matrix 6.1 stream or DTS-ES Discrete 6.1 stream using the DTS Digital Surround 5.1 channel

decoder, even if they have a surround back speaker(s) in their setup.

The GTP-880 will automatically sense the availability of either DTS-ES format and automatically switch the processing mode when required.

DTS NEO:6-C (Cinema): This processing mode can create up to 6 full bandwidth channels from any matrix-encoded 2 channel source. Additionally, this mode can produce the rear surround information from a 5.1 source.

DTS NEO:6-M (Music): In music mode it can expand stereo music material, into a multichannel surround experience.

Stereo: This mode provides conventional 2 channel signals from a stereo or downmixed multichannel to the left and right front speakers only. With an analog and digital input source, the signal is decoded (if AC-3 or DTS) and then downmixed (if a multichannel source) and then bass-management is applied which allows for the HPF on the front speakers to match the LPF set on the subwoofer. Delays are offered on the front and subwoofer channel in this mode as well.

Stereo 5: This mode is designed for use with stereo program material. It is designed to get maximum output from all your speakers. The rear speakers are driven with the same signal as the front left and right, while the center speaker is a monophonic summation of the front speakers.

Stereo 7: This mode is designed for use with stereo program material. It is designed to get maximum output from all your speakers. The rear speakers are driven with the same signal as the front left and right, while the center speaker is a monophonic summation of the front speakers.

Additional Information

More detailed information about the various surround processing options contained in the GTP-880 can be found on the following websites:

www.dolby.com & www.dtsonline.com

Placement of your GTP-880

Your system components need a stable, vibration-free supporting surface. Your ADCOM dealer will be pleased to show you many different types of audio/video equipment racks and cabinets. Keep the GTP-880 (and other audio/video components) away from moisture and out of direct sunlight. Bear in mind that the GTP-880's rear panel is the central connecting point for almost every component in your audio/video system. Leave sufficient room behind the rear panel to accommodate cables, antenna leads, power cords, etc. We recommend a minimum of 5 inches of free space behind the GTP-880 for maximum flexibility.

A distance of 1/2" should be maintained around the GTP-880 for ventilation. Keep your GTP-880 in a room where temperatures remain fairly moderate, and never cover it with table cloths, curtains, newspapers, etc., to avoid potential overheating.

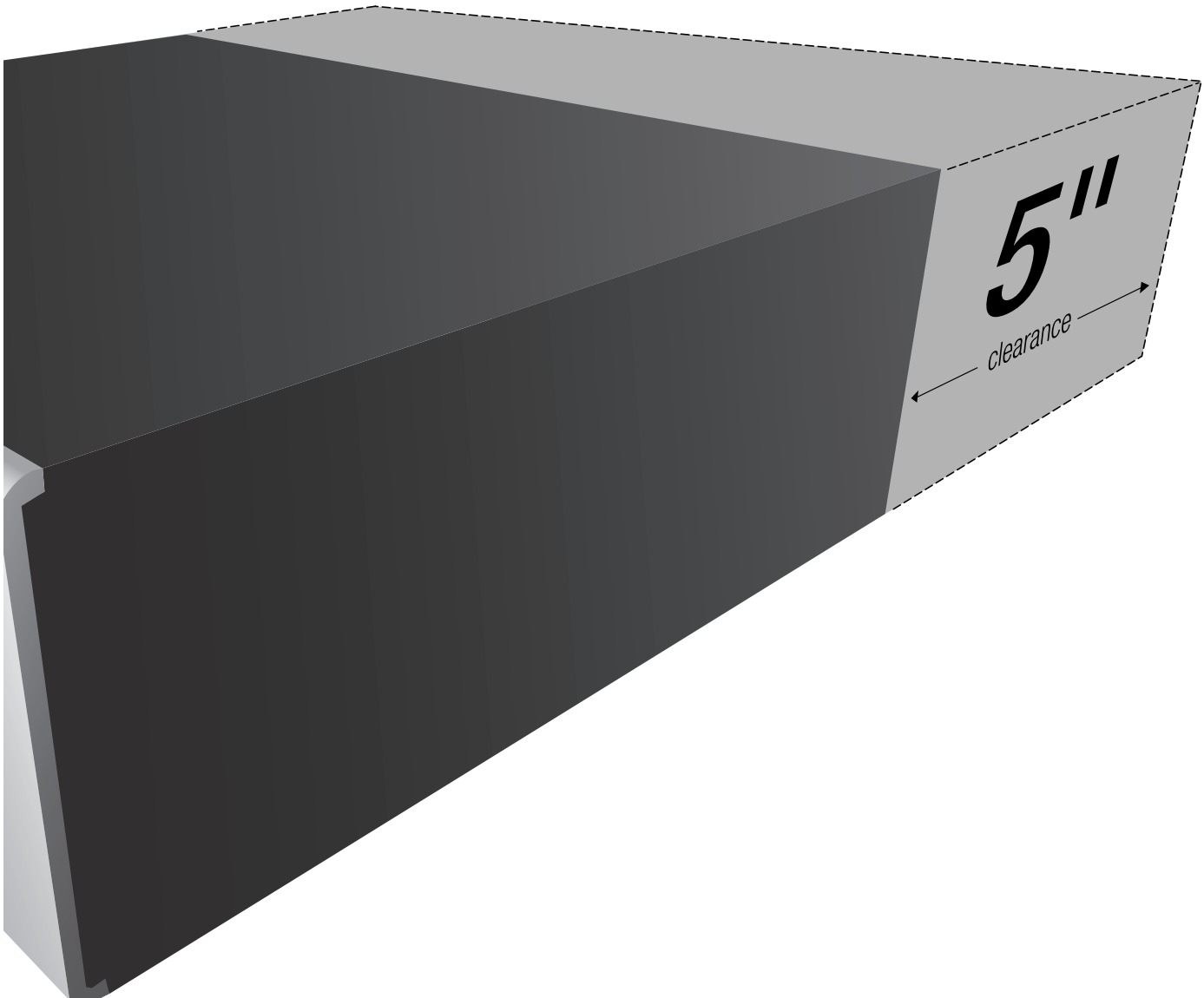

1.5 Rear Panel Illustration

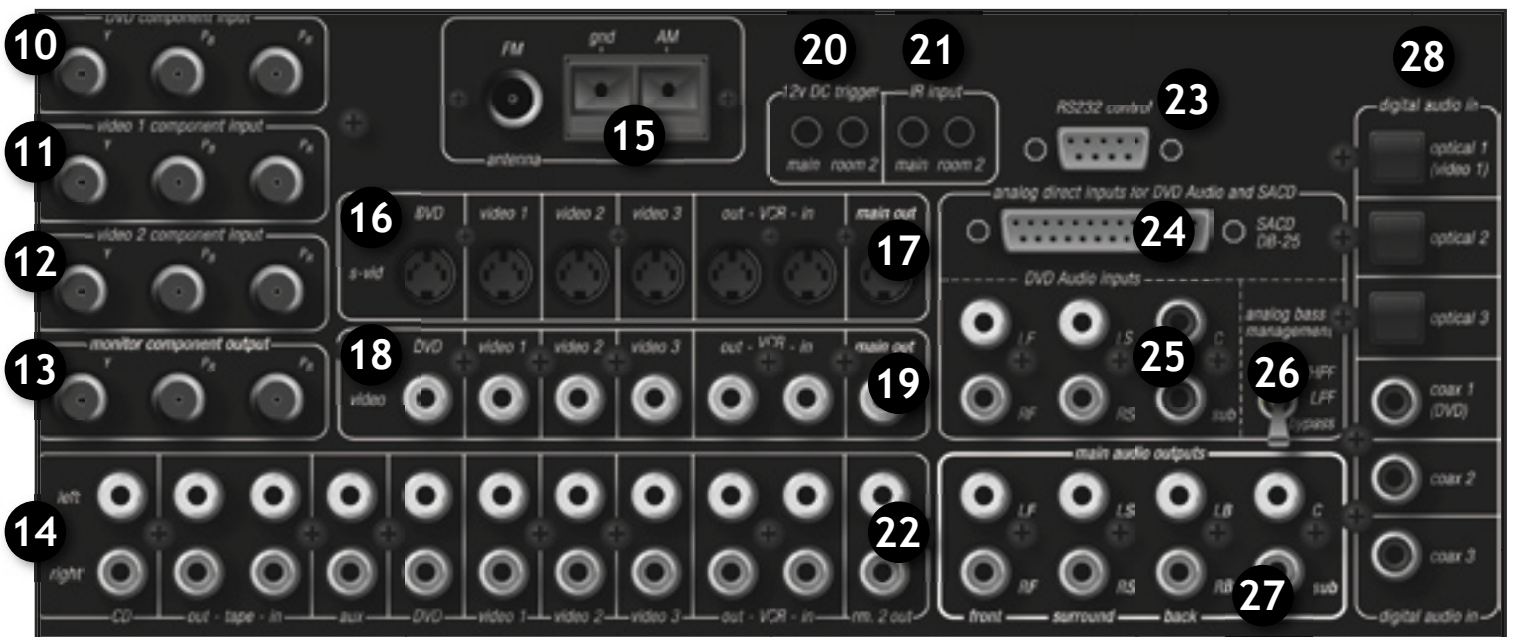

- [10] DVD Component Video Input
- [11] Video 1 Component Input
- [12] Video 2 Component Input
- [13] Monitor Component Output
- [14] Analog Audio Source Inputs
- [15] AM/FM Antenna Inputs
- [16] S-Video Inputs
- [17] S-Video Output
- [18] Composite Video Inputs
- [19] Composite Video Output
- [20] 12V DC Trigger (main/room 2)

- [21] IR Inputs (main/room 2)
- [22] Room 2 Analog Audio Output
- [23] RS232 Control (DB9)
- [24] SACD Input (DB25)
- [25] DVD Audio Input
- [26] Analog Bass Management
- [27] Main Analog Audio Output
- [28] Digital Audio Inputs
- [29] Digital Audio Outputs
- [30] Main Power Switch
- [31] AC Input

1.6 Input & Output System Connections

Like the front panel, the GTP-880's rear panel is carefully arranged to make hookup, configuration, and use as simple as possible. However, the GTP-880's capabilities take some study to use most effectively. We strongly suggest that you read this section of the manual before beginning to hook up your system. You will save yourself much time and effort if you carefully think out what you expect from your system: consider the components you will use, where they'll be placed, and how you will want them to work together. The diagrams and notes in this section will probably answer most of your questions about interfacing the GTP-880 with other components in your system.

Note that the GTP-880's RCA-style jacks have color-coded centers to make connections easier. Use this key to help route cables properly:

- RED** centers = **RIGHT CHANNEL ANALOG AUDIO** inputs or outputs
- WHITE** centers = **LEFT CHANNEL ANALOG AUDIO** inputs or outputs
- YELLOW** centers = **video** inputs (composite)
- BLACK** centers = **DIGITAL AUDIO** inputs and **CENTER CHANNEL** and **SUBWOOFER** inputs and outputs

[10] DVD Component Video Input

Use this set of dedicated jacks to connect a DVD player with component video output.

[11] Video 1 Component Input

Use this set of jacks to connect devices with component video outputs such as a DVD player or HDTV tuner.

[12] Video 2 Component Input

Use this set of jacks to connect devices with component video outputs such as a DVD player or HDTV tuner.

[13] Monitor Component Video Output

Use these jacks to supply component video output to an external monitor that accepts component video signals.

Note: No OSD is available on the component video output.

[14] Analog Audio Source Inputs

Use these inputs for connection to analog audio sources such as a CD player. One in/out tape loop is provided for connection to an audio recorder.

Note: No on screen text messages are available on component video.

[15] AM/FM Antenna Inputs

FM Antenna terminal: Use to connect the supplied FM antenna or an external 75 Ω antenna. Do not over tighten as this may damage the connection.

The supplied FM antenna is for indoor use only. For best signal reception you must fully extend the antenna. Experiment with the antenna's position to obtain the strongest signal. You can attach it to a wall or other surface using push pins or similar apparatus.

If reception is poor with the supplied indoor antenna, using an amplified indoor or outdoor antenna is recommended.

Note: You can only connect a 75 Ω type FM antenna to the GTP-880. If you choose to use an antenna other than the one supplied, be sure to verify that it has the correct type of connector or that you obtain an appropriate adaptor.

Try to avoid using the same antenna for both FM and TV reception since the signals can interfere with each other. If you must use a common FM/TV antenna, be sure that you install a splitter to separate the two signals.

AM Antenna terminals: Connect the supplied AM loop antenna or an external AM antenna to these terminals.

Connect the AM antenna to the terminals labeled AM and gnd (ground) on the rear panel of the GTP-880. Start by pressing the lever on the side of one of the terminals to the right. Next, insert one of the antenna wires into the opening. Finish by returning the lever to the up position, securing the wire. Do the same for the other wire to complete installation.

[16] S-Video Inputs

Use these inputs for connection to the s-video output from sources such as a DVD or LD player, satellite receiver, cable box, PVR or other video source. Note that when the component video inputs are used, connect the analog audio outputs of the source to the DVD or Video 1 jacks, as appropriate.

Connect the VCR-OUT jack to the input of a VCR or other recorder and connect the OUT jack to an s-video input on your video display device.

[17] S-Video Main Output

Connect this output to the s-video input of your monitor or other video display device.

[18] Composite Video Inputs

Use these inputs for connection to the composite video output from sources such as a DVD or LD player, satellite receiver, cable box, PVR or other video source. Note that when the component video inputs are used, connect the analog audio outputs of the source to the DVD or video 1 jacks, as appropriate.

[19] Composite Video main Output

Connect this output to the composite video input of your monitor or other video display device.

[20] 12V DC Trigger (main/room 2)

The DC trigger jacks are used to remotely turn-on other devices in your system when the GTP-880 is powered on. Power is applied to the main trigger output jack when the GTP-880 is turned on from the standby mode. We recommend that this jack be used to turn on a compatible power amplifier such as those available from ADCOM, but it may also be used to activate compatible products such as projection screens or motorized blinds.

Connect a mono mini-plug between the DC trigger main jack on the rear panel of the GTP-880 and the low voltage trigger jack of the device to be controlled to enable remote turn-on of that component. The room 2 trigger jack is activated when the room two system is turned on and should be used for control of amplifiers used to power the speakers installed in room two. It will remain activated as long as the room two system is on, even when the GTP-880 is in the standby mode for the main room.

[21] IR Inputs (main/room 2)

Use the main and room two remote jacks to connect external IR sensors to the GTP-880. When the unit is installed behind doors or where it is not otherwise visible to the remote, connect an optional, external sensor to the main jack. To control the GTP-880's room two system from a remote location, connect an optional remote sensor in the second room to the room two jack.

The remote jacks allow you to extend the on-board remote control sensor on the GTP-880's front panel so that you may continue to control the GTP-880 even when it is installed behind solid or smoked cabinet doors or when the front panel sensor is otherwise not visible to the remote control.

To extend the remote sensor connect an optional remote sensor to the main jack.

The room two jack is provided to enable remote control of the GTP-880's room two system through the use of an optional remote sensor in the second room. Connect the sensor to the room two jack using a mono mini-plug and the wiring specified by the sensor's manufacturer.

[22] Room 2 Analog Audio Output

Use these jacks to supply the analog stereo audio output to an optional audio amplifier used to power the speakers in room two.

Use the L and R channel room two out audio jacks to connect the GTP-880 to the analog audio inputs of an external amplifier or other audio component in a second room. The analog signal present will reflect the input selection of the GTP-880. This may be adjusted using the room two menu or the rm. 2 button on the remote control.

[23] RS232 Control (DB9)

Allows control of the GTP-880 via computer or home automation system.

[24] SACD Inputs (DB25)

Connect the multichannel signal from the analog audio outputs of a device such as a DVD, DVD-A or SACD.

[25] DVD Audio Inputs

Connect the multichannel signal from the analog audio outputs of a device such as a DVD, DVD-A or SACD.

[26] Multichannel Analog Bass Management

Analog bass management is totally separate from the DSP bass management, set up using a three position switch on the rear panel, and applied to multichannel analog inputs.

Up Position: LPF/HPF both on

This position is ideal for owners who have speakers that only have a frequency response that goes down to around 80Hz (@-3dB). All bass information is summed, low-pass-filtered (@ 80Hz) and sent to the subwoofer.

80Hz high-pass crossover for L, C, R, LS, and RS: (12dB/octive)

80Hz low-pass crossover for subwoofer: (12dB/octive)

Middle Position: LPF on/HPF bypassed (subwoofer bass reinforcement mode)

This position is also ideal for owners who have speakers in their system that are full range (or at least have a frequency response that extends below 80Hz) however the user still desires that summed and low-pass-filtered audio information be sent to the subwoofer which helps to

reinforce the low-end frequency response of the system.

80Hz low-pass crossover for subwoofer: 12 dB/octave

Down Position: LPF/HPF complete bypass path (analog multichannel input bass management disabled)

This position is ideal for DVD-Audio/SACD multichannel players which already include integrated bass management, a user has another multichannel analog bass management device, or all speakers in the system are full-range.

[27] Main Analog Audio outputs

Use the seven audio channel output jacks to connect the GTP-880 to an external power amplifier. The eighth jack supplies the output to a powered subwoofer or external subwoofer amplifier.

[28] Digital Audio Inputs

Use these inputs to connect the coaxial and optical digital audio signal output from such digital devices as CD, DVD or LD players. These inputs are fully assignable using the OSD.

[29] Digital Audio Outputs

Use the coaxial and optical digital outputs to connect the GTP-880 to a device such as CD recorder, DAT recorder, or other similar device that accepts a digital audio input.

[30] Main Power Switch

Turns the current to the GTP-880 on or off. Setting this button to the on position (pushed in) supplies power to the unit, enabling use of the standby power button on the front panel. When the main power switch is in the off position, current is cut off to the unit.

[31] AC Input

Use to connect the supplied AC power cord (see page 2).

Before proceeding, please observe the following precautions when connecting devices to your new GTP-880.

Do not plug the power cord into your GTP-880 until all other connections have been made.

Insert the supplied power cord into the AC input of the rear panel of the GTP-880. Do not use a power cord other than the one supplied with the GTP-880. It's designed for use with the GTP-880 and should not be used with any other device.

Caution: Before you plug the power cord into an AC wall outlet, confirm that all connections to the GTP-880 have been made correctly.

Warning: Never disconnect the power cord from the GTP-880 while the other end is plugged into an AC outlet. Doing so may cause an electric shock. Always connect power by plugging into the AC outlet last and disconnect by unplugging from the AC outlet first.

1.7 Connecting Components

Always refer to the instructions that came with the component that you are connecting for specific procedures, warnings and options.

For all analog connections, the red input jacks (R) are used for the right channel, white input jacks (L) are used for the left channel, and yellow input jacks (V) are used for the composite video connection.

Make sure to insert all plugs and connectors securely. Improper connections can result in noise, poor performance, or damage to the equipment.

Do not bundle audio/video connection cables with power cords and speaker cables. Doing so may adversely affect the picture and sound quality. For example, run all the power cords down one side of the cabinet, all the signal cords down the other side, and the speaker wires down the center.

When connecting devices to the digital inputs and outputs, you may also consider hooking up the analog connections to and from the components to insure that all signals can be employed by the GTP-880.

When using the optical input or output jacks, remove the protective cap and keep it in a safe place. When these jacks are not in use the protective cap should be replaced.

When using an optical input or output jack, always use a high-quality optical fiber cable.

Important Note: We strongly recommend that before you connect any loudspeakers to your amplifiers, you complete all needed connections and set up procedures to your GTP-880 as outlined below. This will reduce the chance that a miss connection or other error will produce audio output that might damage your speakers or other components.

External Amplifier

Important Note: Before attempting to plug any jacks into any power amplifier verify that the power amplifier is turned off and/or disconnected from the AC mains. Failure to do so can potentially result in severe damage to your amplifier and loudspeakers.

Use the audio jacks labeled main audio outputs to connect the GTP-880 to an external power amplifier such as the ADCOM 7807 power amplifier. The GTP-880 can output up to 7.1 channels of sound (seven satellite and one subwoofer channel) depending on source components and material.

The output jacks supplied by the GTP-880 are:

left front, center, right front, left surround, right surround, left surround back, right surround back, and subwoofer.

Be sure to verify that the correct outputs are connected to the appropriate input jacks (left front to left front, right surround back to right surround back, etc..)

When a powered subwoofer is used, connect the subwoofer output jack to the Line Input jack on your subwoofer and follow any specific connection and/or configuration instructions supplied with the subwoofer. If your subwoofer is a passive speaker, connect the subwoofer output jack on the GTP-880 to the input of the amplifier used to power the subwoofer, and then connect the subwoofer speaker itself to the amplifier.

DVD Player

Composite: Connect the composite video output from the DVD player to the DVD video input jack on the rear of the GTP-880 using an RCA-type video cable.

S-video: If there is an s-video output on the DVD player, and you have an s-video input on your TV or monitor, connect it to the s-video DVD input on the rear of the GTP-880 using an s-video cable. S-video delivers a better picture than composite connections and should be used whenever possible unless you can use component connections, which deliver better video than s-video.

Component: If the DVD player has component video outputs, connect them to the DVD component video input jacks on the rear of the GTP-880 using an appropriate cable set.

Note: OSD messages do not appear on component video.

Analog Audio: Connect the L and R channel outputs on the DVD player to the DVD in audio jacks on the rear of the GTP-880.

Digital Audio: Connect one of the digital output jacks on the DVD player to one of the coaxial (coax 1-3) or optical (opt 1-3) input jacks on the rear of the GTP-880, depending on the type of connector used by the DVD player. The factory preset for DVD is coax 1. Later, you can configure the GTP-880 to use the specific input that you have chosen.



Use a GFA-7807 Power Amplifier (pictured above) or the GFA-7607 for seven channel surround sound setups. Five channel versions of these amplifiers are also available.

Multi Channel Audio: If your DVD player supplies a multichannel audio output (for DVD Audio or SACD playback), connect the six outputs (special cable sets for this are available from numerous sources) from your player to the six input jacks labeled DVD Audio input on the rear panel of the GTP-880. Be sure match the connections—left to left, right surround to right surround, and so on.

If you are connecting a DVD-Audio or SACD player to the GTP-880 using these jacks, you will need to consider the setting for the analog bass management switch on the GTP-880's rear panel (see previous section for details).

CD Player

Analog: Connect the L and R channel outputs on the CD player to the CD IN jacks on the GTP-880.

Digital: If your CD player has a digital output jack, connect it to one of the coaxial (coax 1-3) or optical (opt 1-3) input jacks on the GTP-880, depending on the type of connector used by the CD player. Later, you will configure the GTP-880 to use the specific input that you have chosen.

Audio Recorder

A recording device such as a cassette deck, MD recorder, DAT deck or CD recorder can be connected to the GTP-880 using either or both of the following methods.

Analog: Connect the L and R audio outputs on the recorder (usually marked "play") to the tape in jacks on the rear of the GTP-880 and connect the L and R audio inputs (usually marked "rec") to the tape out jacks of the GTP-880.

Digital: If your recorder has a digital output jack, connect it to one of the coaxial (coax 1-3) or optical (opt 1-3) input jacks on the GTP-880, depending on the type of connector used by the device. Later, you will configure the GTP-880 to use the specific input that you have chosen.

If your recorder has a digital input jack, connect it to either the coaxial or optical output jack on the GTP-880. The signal from the selected digital input source of the GTP-880 will be sent to the recorder.

Video Components

Before making connections to any video devices, it will help to understand how the GTP-880 routes the video portion of the signal.

Any signal that appears at one of the composite video input jacks (DVD, VCR, video 1, 2 or 3) is automatically sent to the composite video main out and VCR out jacks,

as well as the s-video main out and VCR out jacks.

Any signal that appears at the s-video input jacks (DVD, VCR, video 1, 2 or 3) is automatically sent to the s-video out and VCR out jacks, as well as the composite video out and VCR out jacks.

Any signal that appears at the component video (DVD, video 1, or video 2) input jacks is automatically sent to the monitor component output connection only and only when that source is selected.

Note: To provide the greatest signal flexibility, be sure to connect all available types of inputs and outputs from your video devices. For example, if only the composite video output (yellow RCA jack) connection is made to your display device, component sources will not be available, even if they are connected to the GTP-880.

Video Recorder

A video recording device such as a VCR, PVR (such as a TiVo®, Replay®, UltimateTV®, DishPlayer® or similar device) or DVD recorder can be connected to the GTP-880 using the following methods.

Composite: Connect the composite video output from the recording device to the VCR in composite video jack on the rear of the GTP-880. Connect the recording device's composite video input to the VCR out composite video jack of the GTP-880 using an RCA-type video cable.

S-video: If there is an s-video output on the recording device, connect it to the s-video VCR in input on the rear of the GTP-880 and connect the s-video input to the s-video VCR out using an s-video cable. S-video delivers a better picture than composite connections and should be used whenever possible unless you can use component connections, which deliver better video than s-video.

Component: If the recording device has component video outputs, connect them to one of the component video input jacks (DVD, video 1, video 2) on the rear of the GTP-880 using an appropriate cable set.

Analog Audio: Connect the L and R audio outputs on the recorder to the VCR in audio jacks on the rear of the GTP-880 and connect the L and R inputs of the recorder to the VCR out audio jacks on the GTP-880.

Digital Audio

If your recording device also has a digital audio output jack, connect it to one of the coaxial (coax 1-3) or optical

(opt 1-3) input jacks on the rear of the GTP-880, depending on the type of connector used by the device. Later, you will configure the GTP-880 to use the specific input that you have chosen.

If your recording device also has a digital input jack, connect it to either the coaxial or optical output jack on the rear of the GTP-880, depending on the type of connector used by the device. The signal from the selected input source of the GTP-880 will be sent to the recorder.

Satellite Tuner or Television

Composite: Connect the composite video output from the satellite tuner or television to one of the video input jacks (video 1, 2 or 3) on the rear of the GTP-880 using an RCA-type video cable.

S-video: If there is an s-video output on the satellite tuner or television, connect it to one of the s-video inputs (video 1, 2 or 3) on the rear of the GTP-880 using an s-video cable. S-video delivers a better picture than composite connections and should be used whenever possible unless you can use component connections, which deliver better video than s-video.

Component: If the satellite tuner or television has component video outputs, connect them to one of the component video input jacks (DVD, video 1 or video 2) on the rear of the GTP-880 using an appropriate cable set.

Analog Audio: Connect the L and R channel outputs on the satellite tuner or television to the set of audio input jacks (video 1, 2 or 3) directly under the video jack used on the rear of the GTP-880.

Digital Audio: If your satellite tuner or television has a digital output jack, connect it to one of the coaxial (coax 1-3) or optical (opt 1-3) input jacks on the rear of the GTP-880, depending on the type of connector used by the device. Later, you will configure the GTP-880 to use the specific input that you have chosen.

Video Display

A video display device such as a television monitor, fixed-pixel device (plasma or LCD) or video projector can be connected to the GTP-880 using the following methods.

Composite: Connect the composite video input from the display to the composite video main out jack on the rear of the GTP-880 using an RCA-type video cable.

S-video: If there is an s-video input on the display, connect it to the s-video main out jack on the rear of the GTP-880 using an s-video cable. S-video delivers a better picture than composite connections and should be used whenever possible unless you can use component connections, which deliver better video than s-video.

Component: If the display has component video inputs, connect them to the monitor component output jacks on the rear of the GTP-880 using an appropriate cable set.

Note: Since the GTP-880 converts composite video to s-video and vice versa, you need only make one of those two types of connections between the GTP-880 and your video display. However, when component video connections are used it is still necessary to make either the composite or s-video connections so that you are able to view the on-screen menus and displays which do not appear on the monitor component output. The GTP-880 does not convert from either composite or s-video to component or vice versa.

Connection Diagram: GTP-880 to a GFA-7807 Amplifier

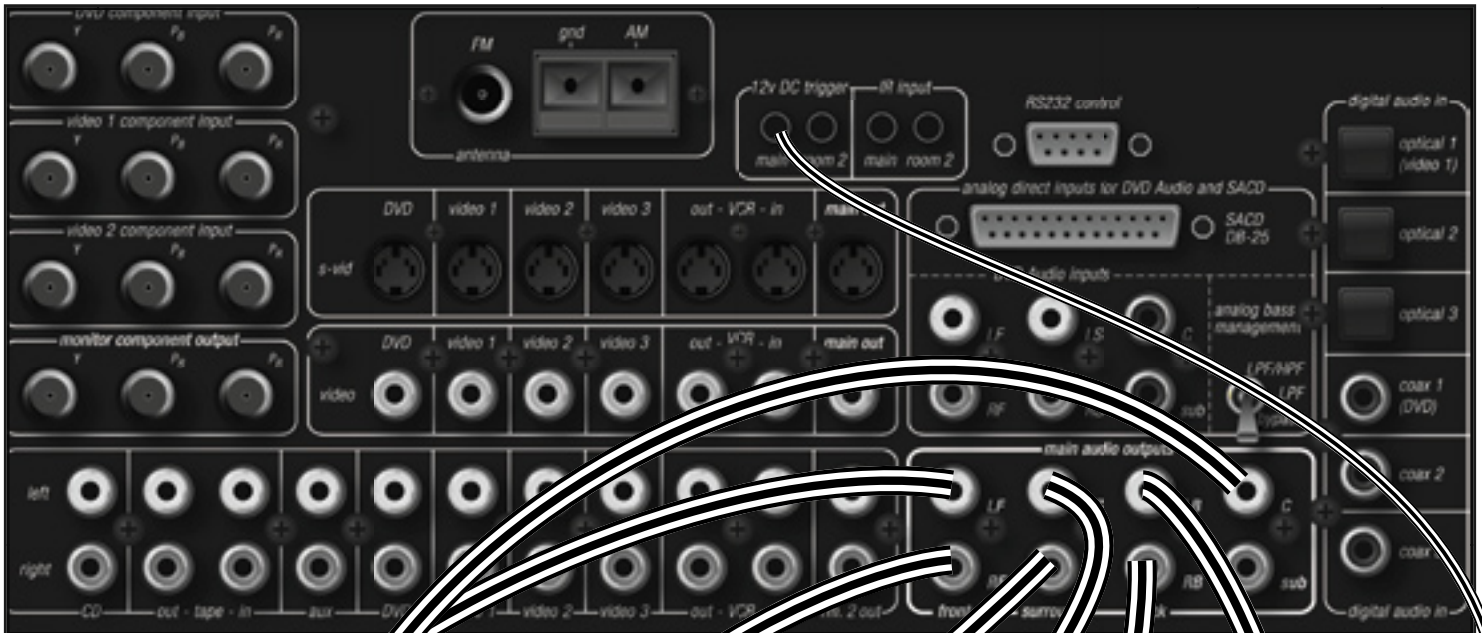

GFA-7807 Power Amplifier

**Connection Diagram:
GDV-850 DVD Player to the GTP-880
Direct Analog Input (DVD Audio)**

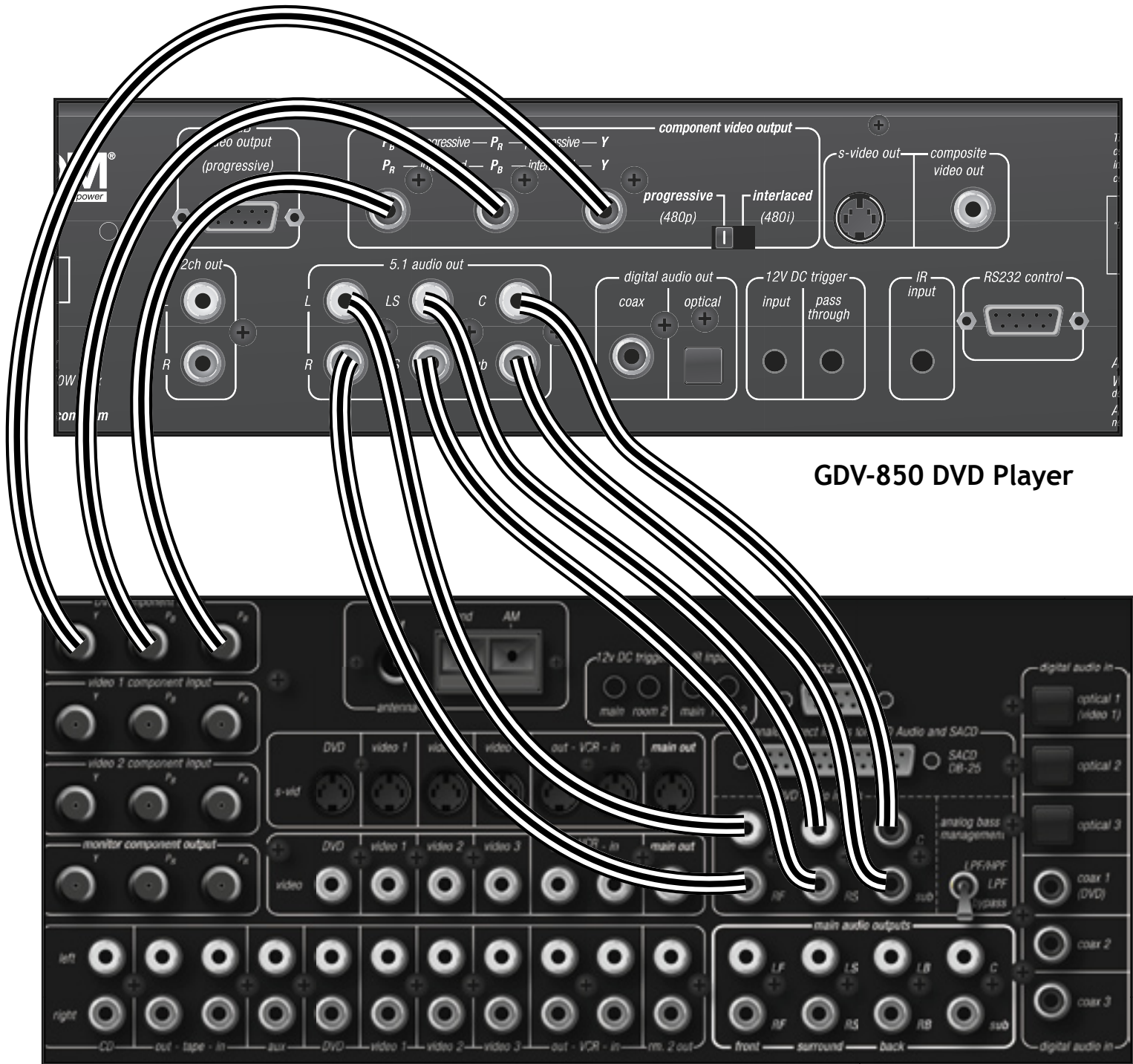

GDV-850 DVD Player

GTP-880 Tuner Preamp

**Connection Diagram:
GDV-850 DVD Player to the GTP-880
Digital & Analog Stereo Input**

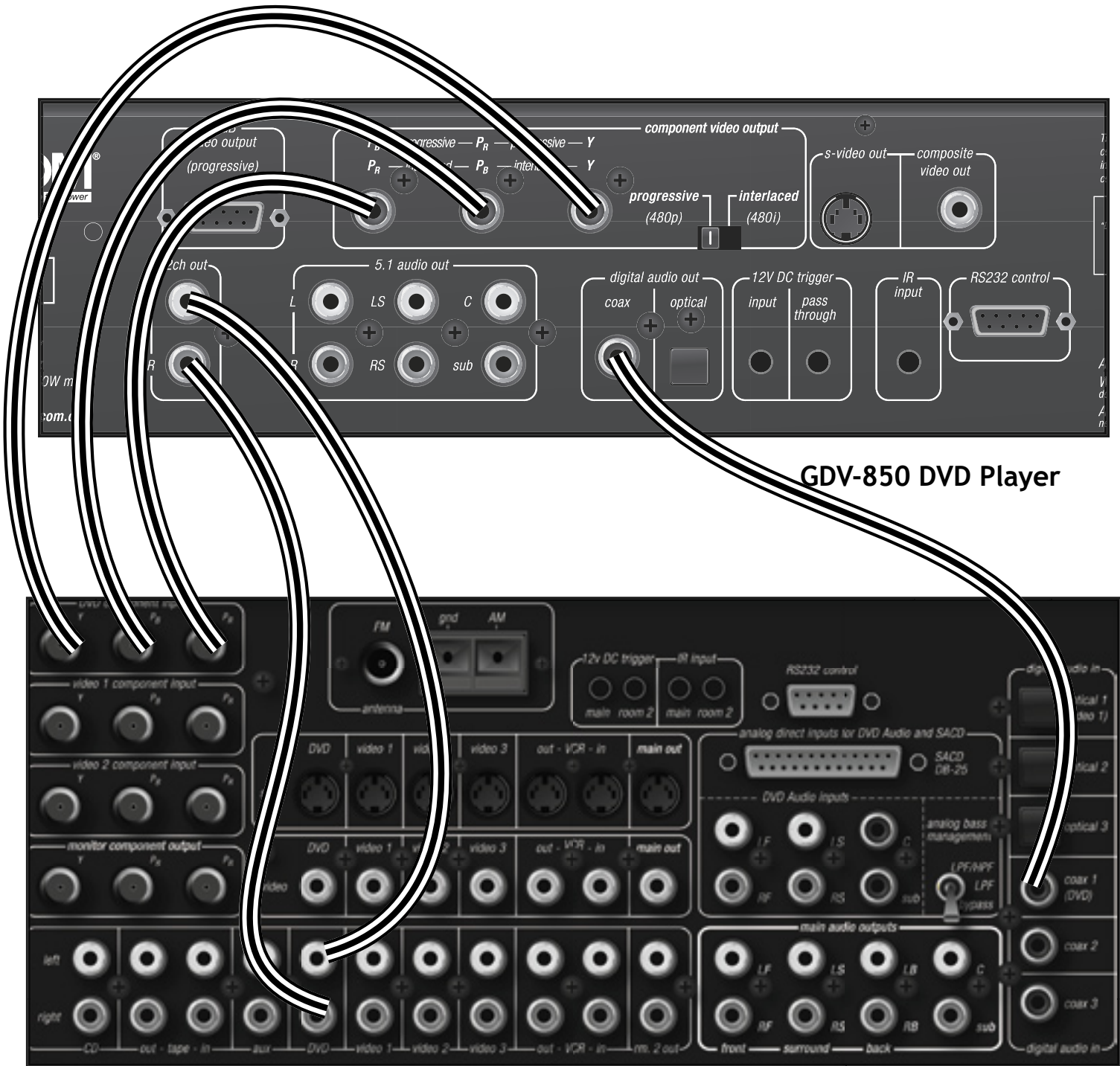

GDV-850 DVD Player

GTP-880 Tuner Preamp

**Connection Diagram:
Analog Source (CD, VCR, etc.)
to the GTP-880 Analog Input**

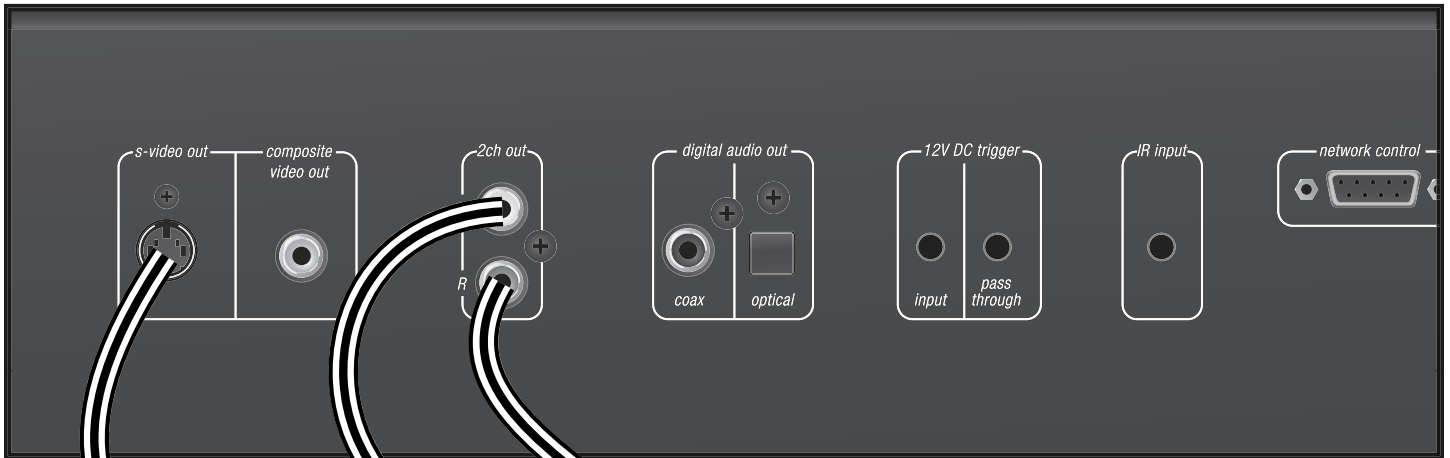

Analog Source



GTP-880 Tuner Preamp

Connection Diagram: GTP-880 Video Outputs

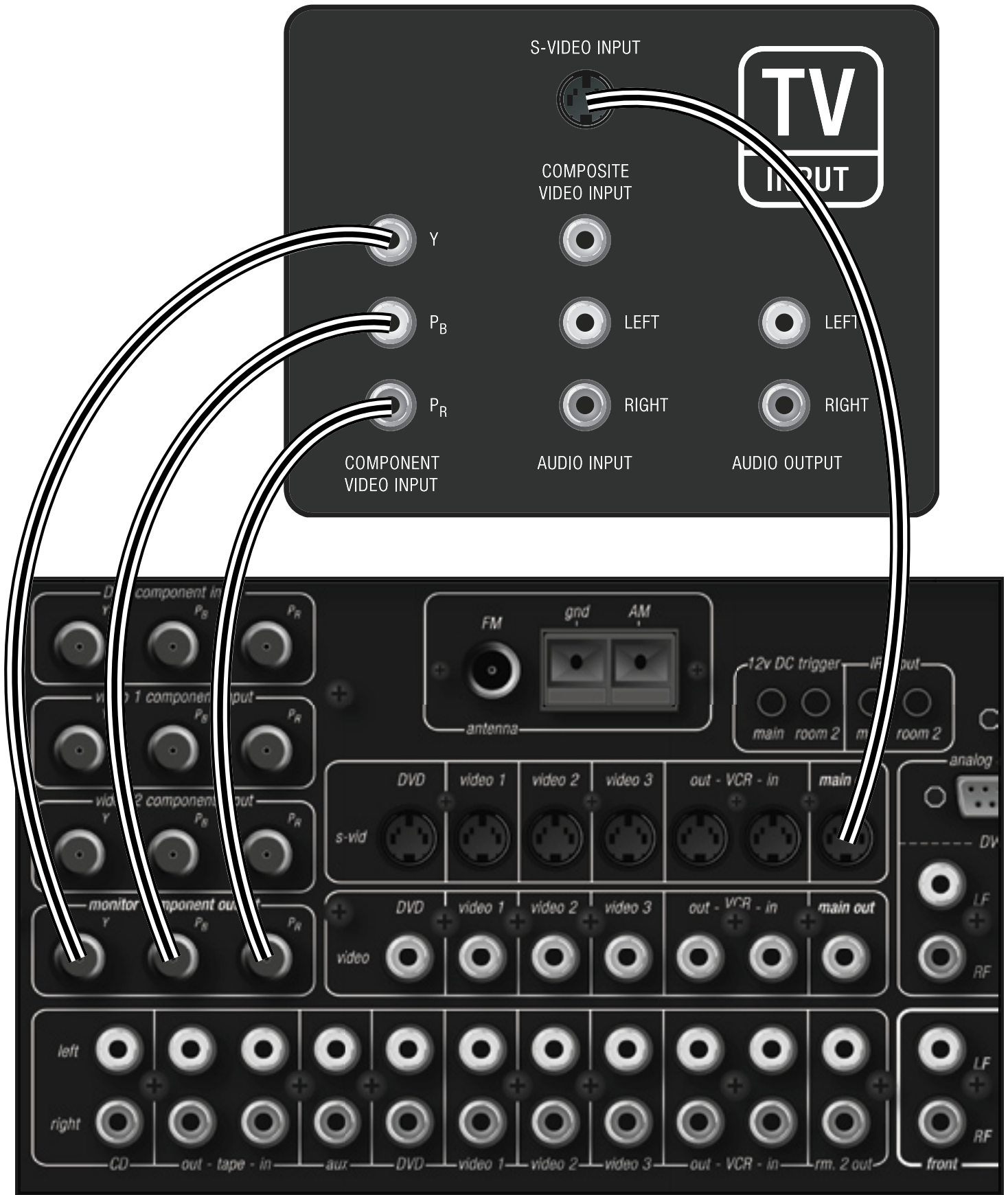



2.1 GRC-810 Remote Control

[32] Main Button

[33] Source Selection Buttons

[34] Power Button

[35] Mute Button

[36] Volume Up & Down Buttons

[37] Tape & Aux Buttons

[38] Dynamic Range Button

[39] Play Button

[40] Main Menu Button

[41] Navigation & Select Buttons

[42] Pause Button

[43] Stop Button

[44] Direct Access Keypad

[45] Surround Mode Buttons

[46] Direct Analog Input Buttons

[47] Random & Repeat Buttons

[48] Ch. Trim & FM/AM Button

[49] Ch. Cal & Memory Button

[50] Th-Eq & P.Scan Button

[51] Tone & Tune Down Button

[52] Bypass & Tune Up Button

[53] Macro Buttons

[54] Room 2 Button

[55] Backlight Button

[56] Dim Button

2.2 Overview of the GRC-810

The GRC-810 remote control is a learning remote control that is capable of saving commands for all remote controls in your home theater system. In this way, you may eliminate the confusion of using multiple remotes. Although such power comes with some added complexity, the complexity is minimal and with some repetition will become second nature.

The single most important aspect to master about the GRC-810 remote control is the function of the source selection buttons at the top of the remote. Each of these buttons cause two things to happen when used. First, they select the corresponding input on the GTP-880. Second, these keys remap all of the other buttons on the remote control. You can think of each of these buttons as having a page of commands associated with it. Some buttons, such as volume up and down, are pre programmed to operate the GTP-880 for each source. These buttons can be “written over” if you like, but default to GTP-880 operations for your convenience.

Most of the GTP-880 remote commands are saved under the main remote page. Whenever you desire to control the GTP-880 via remote, you must first ensure the main page is active. As an example, press main on the remote control. Now, press the dim button. If your GTP-880 is on, the brightness of the front panel display changes. Notice also that the main button on your remote illuminates. This serves as a reminder that the main remote page is currently active. Now press the CD button and then the play button. Notice now that the CD source button lights. The CD remote page is now active. If you have an ADCOM GCD-750 player, this command will cause an idle CD to play. Now, press the dim button again. You should note that CD button does not light. The dim command is not pre programmed in the CD remote page. If your GTP-880 is on you will also notice the display does not respond to this command. Press the main button again to reenter the main remote page. The dim button will now again change the GTP-880 display.

The button description that follows distinguishes the function of each button dependent on the page the remote is in. The remote is shipped from the factory with ADCOM commands saved under the main, tuner, DVD, and CD pages, and with important GTP-880 functions such as volume saved under each page.

The ADCOM universal remote controller is preset to operate all GTP-880 functions (main and tuner device mode) and most ADCOM DVD and CD player functions.

Alkaline batteries are recommended for maximum operating life. Four AAA (R 03) batteries should be fitted in the battery compartment at the rear of the remote control. When replacing batteries, check that they have been put in correctly, as indicated on the base of the battery compartment.

2.3 Remote Features

[32] Main Button

In all modes, button provides access and control to the GTP-880.

[33] Source Selection Buttons

These buttons switch inputs on the GTP-880, making the selected source active. They also can change the functions of other buttons on the remote controller.

[34] Power Button

In all modes, this is pre programmed to toggle on/standby the GTP-880 power.

[35] Mute Button

In all modes, this button is pre programmed to mute outputs of device. Any adjustment of the volume control while in the mute mode will release the muting.

[36] Volume Up & Down Buttons

In all modes, these buttons change the master volume setting of the GTP-880. In all modes except main, they can be reprogrammed with new commands.

[37] Tape & Aux Buttons

In main mode, these are similar to the source selectors described above but they switch only GTP-880 inputs. They do not automatically change the functions of other remote buttons.

[38] Dynamic Range Button

The d. range button, which can be used only in combination with a Dolby Digital source, incrementally reduces the audio track's dynamic range in four steps to allow for comfortable listening under a variety of conditions. Adjust using the ◀ and ▶ buttons or the d.range button.

[39] Play Button

In CD and DVD mode, it is pre programmed for play with an ADCOM GCD-750 and GDV-850.

[40] Main Menu Button

In main mode, this is pre programmed to enter on screen menu of the GTP-880.

[41] Navigation & Select Buttons

The arrow buttons allow navigation throughout the GTP-880 OSD (ON Screen Display) menus (as well as the menus of other devices, once the commands are learned).

Select button: In main mode, this is pre programmed to enter a selection chosen via the menu system.

[42] Pause Button

In CD and DVD mode, it is pre programmed for pause with an ADCOM GCD-750 and GDV-850.

[43] Stop Button

In CD and DVD mode, it is pre programmed for stop with an ADCOM GCD-750 and GDV-850.

[44] Direct Access Keypad

In CD mode, buttons are pre programmed as track access commands for the ADCOM CD player. Buttons "1" through "10," and "+10"

In tuner mode these buttons allow direct access to preset stations in memory.

In DVD mode, buttons work in conjunction with direct chapter navigation. Use the go to/enter to jump to a specific chapter or scene.

[45] Surround Mode Buttons

In main mode, these are pre programmed to cycle through the available surround modes of the GTP-880.

[46] Direct Analog Input Buttons

These buttons switch the analog inputs to one of the analog direct inputs. DVD-Audio, SACD or a 2 channel bypass.

[47] Random & Repeat Buttons

In CD mode, these buttons are pre programmed as "random" and "repeat" commands for ADCOM CD player.

[48] Ch. Trim & FM/AM Button

In main mode, this button cycles through channels adjusting trim in 1dB steps, -15dB to +10dB. Use the left and right arrows to make adjustments. In tuner mode this button switches the tuner between FM and AM frequencies.

[49] Ch. Cal & Memory Button

In main mode, this button cycles through channels adjusting level in 1dB steps, -15dB to +10dB. Use the left and right arrows to make adjustments. In tuner mode this

button is used to program radio stations in memory.

[50] Th-Eq & P.Scan Button

In main mode this button turns theater compensation processing on and off.

In tuner mode this button scans the AM or FM stations preset in the tuner's memory.

[51] Tone & Tune Down Button

In main mode this button cycles between the treble and bass level control, use the left and right buttons to make adjustments.

In tuner mode this button adjusts the GTP-880 tuner's frequency down.

[52] Bypass & Tune Up Button

In main mode this button turns tone bypass on and off. In tuner mode this button adjusts the GTP-880 tuner's frequency up.

[53] Macro Buttons

These buttons are programmable for use with any source.

[54] Room 2 Button

In any mode, this button is used turn room 2 on and off, as well as adjust room settings using the ◀ ▶ buttons.

[55] Backlight Button

No programming capabilities. Button backlights all keys for eight (8) seconds when pressed.

[56] Dim Button

In main mode, button is pre programmed to dim GTP-880's information display.

2.4 Remote Function Table

The tables on the following pages supplement the information you've just read. Use it to quickly review button functions. The controller's capabilities are extensive and may be somewhat intimidating at first. However, you will soon find that its logical button arrangement and programming capabilities will greatly increase your enjoyment as you discover the ease with which you can operate your entire system from just one remote! Look down the left-hand column until you see the button you want to learn about. Then look under main to see if it is pre programmed for a GTP-880 function, under CD to see what CD commands are pre programmed, and under tuner to see all pre programmed tuning functions.

Buttons	Function: Main	Code	Function: DVD	Code
main	selects 880 codes	195	selects 880 codes	195
DVD	selects 880 dvd input	135	selects 880 dvd input	135
VCR	selects 880 vcr input	134	selects 880 vcr input	134
CD	selects 880 cd input	136	selects 880 cd input	136
vid 1	selects 880 video 1 input	131	selects 880 video 1 input	131
vid 2	selects 880 video 2 input	132	selects 880 video 2 input	132
vid 3	selects 880 video 3 input	133	selects 880 video 3 input	133
tuner	selects 880 tuner	137	selects 880 tuner	137
power	toggles 880 power on/off	128	toggles dvd power on/off	101
tape	selects 880 tape input	138	selects 880 tape input	138
aux	selects 880 aux input	139	selects 880 aux input	139
mute	toggles 880 audio mute	130	toggles dvd audio mute	121
d.range	toggles 880 night mode	223	toggles 880 night mode	223
Vol ▲	880 master volume up	213	880 master volume up	213
Vol ▼	880 master volumer dn	209	880 master volumer dn	209
▲	880 navigation up	64	dvd navigation up	100
▼	880 navigation down	65	dvd navigation downdvd	61
▶	880 navigation right	67	navigation right	104
◀	880 navigation left	66	dvd navigation left	60
select	880 select/enter	3	dvd select/enter	113
play	dvd - play	113	dvd - play	113
menu	calls up 880 osd menu	129	dvd menu	99
pause	dvd - pause	118	dvd - pause/step	49
stop	dvd - stop	50	dvd - stop	50
1	1	144	1	36
2	2	145	2	37
3	3	146	3	127
4	4	147	4	39
5	5	148	5	40
6	6	149	6	41
7	7	150	7	42
8	8	151	8	43
9	9	152	9	44
0	0	154	0	35
+10	+10	153	+10	45
enter	direct tune entry	210	dvd go-to	116
7.1m2	7.1m2 on/off	84	<i>programmable</i>	
Dolby	toggles dolby modes	87	<i>programmable</i>	
DTS	toggles dts modes	86	<i>programmable</i>	
stereo	toggles stereo modes	85	<i>programmable</i>	
DVD-A	toggles dvd-a direct	71	<i>programmable</i>	
SACD	toggles sacd direct	70	<i>programmable</i>	
2-ch	toggles 2 channel direct	68	<i>programmable</i>	
random	<i>programmable</i>		<i>programmable</i>	
repeat	dvd - repeat	122	dvd - repeat (1/all)	122
ch. trim / AM/FM	channel bal. trim adjust	199	<i>programmable</i>	
ch. cal / mem	noise gen./trim adjust	80	<i>programmable</i>	
th-eq / p.scan	toggles comp on/off	222	<i>programmable</i>	
tone / tune ◀	toggles treble/bass adj.	207	<i>programmable</i>	
bypass / tune ▶	toggles tone bypass	77	<i>programmable</i>	
m1	<i>programmable</i>		<i>programmable</i>	
m2	<i>programmable</i>		<i>programmable</i>	
m3	<i>programmable</i>		<i>programmable</i>	
m4	<i>programmable</i>		<i>programmable</i>	
rm. 2	displays room 2 setup	203	<i>programmable</i>	
backlight	backlight		backlight	
dim	toggles vfd brightness	202	<i>programmable</i>	

Buttons	Function: CD	Code	Function: Tuner	Code
main	selects 880 codes	195	selects 880 codes	195
DVD	selects 880 dvd input	135	selects 880 dvd input	135
VCR	selects 880 vcr input	134	selects 880 vcr input	134
CD	selects 880 cd input	136	selects 880 cd input	136
vid 1	selects 880 video 1 input	131	selects 880 video 1 input	131
vid 2	selects 880 video 2 input	132	selects 880 video 2 input	132
vid 3	selects 880 video 3 input	133	selects 880 video 3 input	133
tuner	selects 880 tuner	137	selects 880 tuner	137
power	toggles cd power on/off	6	toggles 880 power on/off	128
tape	selects 880 tape input	138	selects 880 tape input	138
aux	selects 880 aux input	139	selects 880 aux input	139
mute	toggles 880 audio mute	130	toggles 880 audio mute	130
d.range	toggles 880 night mode	223	toggles 880 night mode	223
Vol ▲	880 master volume up	213	880 master volume up	213
Vol ▼	880 master volumer dn	209	880 master volumer dn	209
▲	<i>programmable</i>		<i>programmable</i>	
▼	<i>programmable</i>		<i>programmable</i>	
▶	skip ahead	0	<i>programmable</i>	
◀	skip back	1	<i>programmable</i>	
select	<i>programmable</i>		<i>programmable</i>	
play	play	5	<i>programmable</i>	
menu	<i>programmable</i>		<i>programmable</i>	
pause	pause	14	<i>programmable</i>	
stop	stop	4	<i>programmable</i>	
1	track 1	16	1	144
2	track 2	17	2	145
3	track 3	18	3	146
4	track 4	19	4	147
5	track 5	20	5	148
6	track 6	21	6	149
7	track 7	22	7	150
8	track 8	23	8	151
9	track 9	24	9	152
0	track 10	26	0	154
+10	plus 10	25	+10	153
enter	<i>programmable</i>		direct tune entry	210
7.1m2	<i>programmable</i>		<i>programmable</i>	
Dolby	<i>programmable</i>		<i>programmable</i>	
DTS	<i>programmable</i>		<i>programmable</i>	
stereo	<i>programmable</i>		<i>programmable</i>	
DVD-A	<i>programmable</i>		<i>programmable</i>	
SACD	<i>programmable</i>		<i>programmable</i>	
2-ch	<i>programmable</i>		<i>programmable</i>	
random	random	78	<i>programmable</i>	
repeat	repeat	73	<i>programmable</i>	
ch. trim / AM/FM	<i>programmable</i>		select tuner & toggle am/fm	143
ch. cal / mem	<i>programmable</i>		tuner memory set	11
th-eq / p.scan	<i>programmable</i>		selects presets/tune	211
tone / tune ◀	<i>programmable</i>		tuner down	141
bypass / tune ▶	<i>programmable</i>		tuner up	140
m1	<i>programmable</i>		rds	2
m2	<i>programmable</i>		pty	69
m3	<i>programmable</i>		display	196
m4	<i>programmable</i>		sleep	198
rm. 2	<i>programmable</i>		<i>programmable</i>	
backlight	backlight		backlight	
dim	<i>programmable</i>		<i>programmable</i>	

Buttons	Function: VCR	Code	Function: Video 1	Code
main	selects 880 codes	195	selects 880 codes	195
DVD	selects 880 dvd input	135	selects 880 dvd input	135
VCR	selects 880 vcr input	134	selects 880 vcr input	134
CD	selects 880 cd input	136	selects 880 cd input	136
vid 1	selects 880 video 1 input	131	selects 880 video 1 input	131
vid 2	selects 880 video 2 input	132	selects 880 video 2 input	132
vid 3	selects 880 video 3 input	133	selects 880 video 3 input	133
tuner	selects 880 tuner	137	selects 880 tuner	137
power	toggles 880 power on/off	128	toggles 880 power on/off	128
tape	selects 880 tape input	138	selects 880 tape input	138
aux	selects 880 aux input	139	selects 880 aux input	139
mute	toggles 880 audio mute	130	toggles 880 audio mute	130
d.range	toggles 880 night mode	223	toggles 880 night mode	223
Vol ▲	880 master volume up	213	880 master volume up	213
Vol ▼	880 master volumer dn	209	880 master volumer dn	209
▲	<i>programmable</i>		<i>programmable</i>	
▼	<i>programmable</i>		<i>programmable</i>	
▶	<i>programmable</i>		<i>programmable</i>	
◀	<i>programmable</i>		<i>programmable</i>	
select	<i>programmable</i>		<i>programmable</i>	
play	<i>programmable</i>		<i>programmable</i>	
menu	<i>programmable</i>		<i>programmable</i>	
pause	<i>programmable</i>		<i>programmable</i>	
stop	<i>programmable</i>		<i>programmable</i>	
1	<i>programmable</i>		<i>programmable</i>	
2	<i>programmable</i>		<i>programmable</i>	
3	<i>programmable</i>		<i>programmable</i>	
4	<i>programmable</i>		<i>programmable</i>	
5	<i>programmable</i>		<i>programmable</i>	
6	<i>programmable</i>		<i>programmable</i>	
7	<i>programmable</i>		<i>programmable</i>	
8	<i>programmable</i>		<i>programmable</i>	
9	<i>programmable</i>		<i>programmable</i>	
0	<i>programmable</i>		<i>programmable</i>	
+10	<i>programmable</i>		<i>programmable</i>	
enter	<i>programmable</i>		<i>programmable</i>	
7.1m2	<i>programmable</i>		<i>programmable</i>	
Dolby	<i>programmable</i>		<i>programmable</i>	
DTS	<i>programmable</i>		<i>programmable</i>	
stereo	<i>programmable</i>		<i>programmable</i>	
DVD-A	<i>programmable</i>		<i>programmable</i>	
SACD	<i>programmable</i>		<i>programmable</i>	
2-ch	<i>programmable</i>		<i>programmable</i>	
random	<i>programmable</i>		<i>programmable</i>	
repeat	<i>programmable</i>		<i>programmable</i>	
ch. trim / AM/FM	<i>programmable</i>		<i>programmable</i>	
ch. cal / mem	<i>programmable</i>		<i>programmable</i>	
th-eq / p.scan	<i>programmable</i>		<i>programmable</i>	
tone / tune ◀	<i>programmable</i>		<i>programmable</i>	
bypass / tune ▶	<i>programmable</i>		<i>programmable</i>	
m1	<i>programmable</i>		<i>programmable</i>	
m2	<i>programmable</i>		<i>programmable</i>	
m3	<i>programmable</i>		<i>programmable</i>	
m4	<i>programmable</i>		<i>programmable</i>	
rm. 2	<i>programmable</i>		<i>programmable</i>	
backlight	backlight		backlight	
dim	<i>programmable</i>		<i>programmable</i>	

Buttons	Function: Video 2	Code	Vunction: Video 3	Code
main	selects 880 codes	195	selects 880 codes	195
DVD	selects 880 dvd input	135	selects 880 dvd input	135
VCR	selects 880 vcr input	134	selects 880 vcr input	134
CD	selects 880 cd input	136	selects 880 cd input	136
vid 1	selects 880 video 1 input	131	selects 880 video 1 input	131
vid 2	selects 880 video 2 input	132	selects 880 video 2 input	132
vid 3	selects 880 video 3 input	133	selects 880 video 3 input	133
tuner	selects 880 tuner	137	selects 880 tuner	137
power	toggles 880 power on/off	128	toggles 880 power on/off	128
tape	selects 880 tape input	138	selects 880 tape input	138
aux	selects 880 aux input	139	selects 880 aux input	139
mute	toggles 880 audio mute	130	toggles 880 audio mute	130
d.range	toggles 880 night mode	223	toggles 880 night mode	223
Vol ▲	880 master volume up	213	880 master volume up	213
Vol ▼	880 master volumer dn	209	880 master volumer dn	209
▲	<i>programmable</i>		<i>programmable</i>	
▼	<i>programmable</i>		<i>programmable</i>	
▶	<i>programmable</i>		<i>programmable</i>	
◀	<i>programmable</i>		<i>programmable</i>	
select	<i>programmable</i>		<i>programmable</i>	
play	<i>programmable</i>		<i>programmable</i>	
menu	<i>programmable</i>		<i>programmable</i>	
pause	<i>programmable</i>		<i>programmable</i>	
stop	<i>programmable</i>		<i>programmable</i>	
1	<i>programmable</i>		<i>programmable</i>	
2	<i>programmable</i>		<i>programmable</i>	
3	<i>programmable</i>		<i>programmable</i>	
4	<i>programmable</i>		<i>programmable</i>	
5	<i>programmable</i>		<i>programmable</i>	
6	<i>programmable</i>		<i>programmable</i>	
7	<i>programmable</i>		<i>programmable</i>	
8	<i>programmable</i>		<i>programmable</i>	
9	<i>programmable</i>		<i>programmable</i>	
0	<i>programmable</i>		<i>programmable</i>	
+10	<i>programmable</i>		<i>programmable</i>	
enter	<i>programmable</i>		<i>programmable</i>	
7.1m2	<i>programmable</i>		<i>programmable</i>	
Dolby	<i>programmable</i>		<i>programmable</i>	
DTS	<i>programmable</i>		<i>programmable</i>	
stereo	<i>programmable</i>		<i>programmable</i>	
DVD-A	<i>programmable</i>		<i>programmable</i>	
SACD	<i>programmable</i>		<i>programmable</i>	
2-ch	<i>programmable</i>		<i>programmable</i>	
random	<i>programmable</i>		<i>programmable</i>	
repeat	<i>programmable</i>		<i>programmable</i>	
ch. trim / AM/FM	<i>programmable</i>		<i>programmable</i>	
ch. cal / mem	<i>programmable</i>		<i>programmable</i>	
th-eq / p.scan	<i>programmable</i>		<i>programmable</i>	
tone / tune ◀	<i>programmable</i>		<i>programmable</i>	
bypass / tune ▶	<i>programmable</i>		<i>programmable</i>	
m1	<i>programmable</i>		<i>programmable</i>	
m2	<i>programmable</i>		<i>programmable</i>	
m3	<i>programmable</i>		<i>programmable</i>	
m4	<i>programmable</i>		<i>programmable</i>	
rm. 2	<i>programmable</i>		<i>programmable</i>	
backlight	backlight		backlight	
dim	<i>programmable</i>		<i>programmable</i>	

2.5 Programming the GRC-810 Remote

As you've already seen, the GRC-810 is pre programmed to control ADCOM's GTP-880 tuner preamp and the GCD-750 CD and GDV-850 DVD players. In addition, it has seven "component memory banks" available so you can program the remote to learn commands for your DVD player, satellite box, laser disc player, VCR, etc. This lets you use one remote controller for your entire system.

Using Pre Programmed Commands

Using the remote controller's pre programmed commands is simple. For most GTP-880 functions (volume up/down, changing surround modes, etc.), follow these easy steps.

1. Press the main source selector button. This tells the remote that you want to use GTP-880 pre programmed commands. The main button will flash red to tell you it understands.
2. Press the appropriate function button (volume up, volume down, etc.) If you've selected a button that actually triggers a GTP-880 command, the main button will again flash red to confirm your choice. If the main button does not flash, you've selected a function button that isn't pre programmed.

For tuner functions (changing stations, etc.):

1. Press the tuner source selector button. It will flash red.
2. Press the tuning up (or tuning down) function button to change stations. The tuner source selector will flash red to confirm that the function button you've selected actually triggers a command. (Again, use the table to see which buttons are pre programmed.) Press the CD source selector first to access pre programmed commands for ADCOM CD players.

Note: You can program new commands over the pre programmed commands in tuner and CD if you wish. However, you cannot program any buttons, even those unprogrammed with GTP-880 command codes, while you're in main mode. This safety feature assures you that you will always be able to fully enjoy the GTP-880's capabilities.

Programming Your Own Commands

You can supplement pre programmed commands with commands to operate other components. Before you begin to follow these steps, note the status LED located at the top left corner just above the remote's button panel: It will flash red, orange, or green to signal particular functions as you enter new commands into your ADCOM remote.

Begin by deciding which source component's commands you will be transferring to the ADCOM remote. Then press

the appropriate source selector button. For example, if you're teaching your ADCOM remote commands for your video 1 source, press the vid 1 source selector first. You can "teach" your remote new commands for any function button (except backlight) after you've selected DVD, VCR, CD, vid 1, vid 2, vid 3 and tuner.

1. Place the source component's remote "head to head" with the ADCOM remote. They should be in line with each other about 2 to 3 inches apart.
2. Press the ADCOM remote's appropriate source selector and select buttons simultaneously. Hold both buttons until the status LED turns orange and the source selector button glows red. Both indicators should remain lit.
3. Decide which function button on the ADCOM remote you want to learn a new command. Press it. The orange status LED will begin to flash and the source selector LED will go out.
4. Find the corresponding button on the source component's remote. Press and hold it until the status LED on the ADCOM remote flashes green once and remains green until the button on the source remote is released. Once the button on the source remote is released, the status LED will start flashing orange again.
5. Verify that the ADCOM remote has learned the new command by pressing and holding the same button on the source remote. The ADCOM remote's status LED should flash green twice and then go back to steady orange. This indicates successful programming. Release the button on the source remote.

Repeat steps 3 through 5 for any other commands you want to teach your ADCOM remote for that source component.

Save the commands you've just programmed into the ADCOM remote by pressing and holding the appropriate source selector and select buttons simultaneously. Hold until the status LED and source selector LED flash twice and then go out. Repeat these steps for any other source commands you wish to program.

Deleting Individual Commands

1. Press the ADCOM remote's source selector and select buttons simultaneously and hold until the orange status LED and the source selector button glow steadily.
2. Press the function button you wish to clear. The status LED will flash continuously.

3. Press the backlight button. The status LED will then flash green twice and then revert to steady orange. The source selector button will continue to glow.

Repeat steps 2 and 3 for any other command you wish to delete for the same source component.

4. Exit "delete mode" by pressing and holding the source selector and select buttons simultaneously. The orange status LED and the source selector button will turn off.

Deleting all the Programmed Commands for one Source Component

1. Press the ADCOM remote's source selector and select buttons simultaneously and hold until the orange status LED and the source selector button turn on and remain lit.

2. Press and hold down the backlight button. The red status LED and the device button will flash five times, the status LED will then flash green twice and turn to a constant orange, indicating that all the learned information for the device mode selected has been erased.

3. To exit this feature, press and hold the ADCOM remote's source selector and select buttons simultaneously. The orange status LED and the source selector button will flash twice and then turn off.

Deleting all the Commands for Every Source Component

Note: This procedure erases every programmed command accessed under the selected DVD, VCR, CD, vid 1, vid 2, vid 3, and tuner input selectors. Make sure you really want to do this before following the step below.

Press and hold the video two input selector and the backlight button simultaneously. The red status LED will flash twelve times. The status LED will then flash green once, followed by a single orange pulse.

All LEDs will then turn off, indicating that every learned command in the ADCOM remote has been erased.

2.6 Programming Macro Buttons

"Macro" commands are simply a series of individual commands initiated by pushing just one button.

The ADCOM remote can learn up to 10 individual commands and store them as a single macro.

There are four "macro initiator" buttons on the ADCOM remote: m1, m2, m3, and m4. Each "macro initiator" can

store and transmit either of two complete macros, depending on which source selector is active when you push it.

For macro programming purposes, think of the source selectors as being in two groups: main, DVD, VCR, and CD in group 1; vid 1, vid 2, vid 3, and tuner in group 2. When you program a "group 1" macro, you will start by pushing the main source selector. After you've completed and memorized that macro command series, you can initiate it whenever you're in main, DVD, VCR or CD modes. Similarly, you will program "group 2" macros by pushing vid 1 first and can use them whenever the video 1, video 2, video 3, or tuner inputs are active.

1. Press either the group 1 or group 2 source selector button (main or vid 1 respectively) and the mute button simultaneously. Hold both buttons until the red status LED and the input selector button remain lighted.

2. Press the macro initiator button (m1, m2, m3 or m4) you wish to program.

3. Select and press up to ten buttons you wish to store in the macro. Both source selector and function buttons count as individual commands. Remember that each macro can hold only up to ten individual commands.

4. Press the random button to save the macro. The red status LED and input selector button will blink twice to confirm programming and then turn off.

- To add a power (on/off) command to the macro, use the mute button in place of the power button.

- The random/tone buttons cannot be used in a macro sequence.

Deleting Macro Initiator Buttons:

1. Press either the group 1 or group 2 source selector button (main or vid 1 respectively) and the mute button simultaneously. Hold both buttons until the red status LED and the input selector button remain lighted.

2. Press the macro initiator button (m1, m2, m3 or m4) you wish to delete.

3. Press the random button. The red status LED and input selector button will blink twice to confirm deletion of the macro.

2.7 Function and Data List for GTP-880 (Discrete) Remote Control via IR

Custom Code: 1AE8h

Code Type: NEC2

Carrier Frequency: 38kHz

Command	GTP-880 Function	IR: D7~D0	Hex	Deci	Turn on
pwr on	turns power full on	0101 0100	54h	84	yes
pwr off	turns power off (standby)	0101 0101	55h	85	
dvd-a on	direct selection of dvd-a analog direct input	1100 1011	CBh	203	
dvd-a off	direct de-selection of dvd-a analog direct input	1101 0111	D7h	215	
sacd on	direct selection of sacd analog direct input	1001 0000	90h	144	
sacd off	direct de-selection of sacd analog direct input	1001 1000	98h	152	
2 channel on	direct selection of stereo bypass mode	1001 0001	91h	145	
2 channel off	direct de-selection of stereo bypass mode	1100 1101	CDh	205	
otp1	direct select digital input opt 1	1001 0010	92h	146	
opt2	direct select digital input opt 2	1001 0011	93h	147	
opt3	direct select digital input opt 3	1101 0000	D0h	208	
coax1	direct select digital input coax 1	1101 0001	D1h	209	
coax2	direct select digital input coax 2	1101 0010	D2h	210	
coax3	direct select digital input coax 3	1101 0011	D3h	211	
fm-mono	direct select fm mode monophonic	0001 0100	14h	20	
fm-stereo	direct select fm mode stereophonic	0001 0101	15h	21	
bypass-on	turns on tone bypass function	0001 0110	16h	22	
bypass-off	turns off tone bypass function	0001 0111	17h	23	
mute-on	mutes main audio	0101 0110	56h	86	
mute-off	unmutes main audio	0101 0111	57h	87	
room2-on	direct select room 2 audio on	1100 1110	CEh	206	
room2-off	direct select room 2 audio off	1100 1111	CFh	207	
mute2-on	mutes room 2 audio	1101 0101	D5h	213	
mute2-off	unmutes room 2 audio	1101 0110	D6h	214	
room2 vol +	room 2 volume up	0101 0010	52h	82	
room2 vol -	room 2 volume down	0101 0011	53h	83	
t.comp-on	direct select theater compensation on	1000 1011	8Bh	139	
t.comp-off	direct select theater compensation off	1100 1000	C8h	200	
plll-c	direct select pro logic II cinema	0101 1100	5Ch	92	
plll-m	direct select pro logic II music	0101 1101	5Dh	93	
dolby pl	direct select pro logic emulation	0000 1110	0Eh	14	
neo:6c	direct select dts neo:6 cinema	0101 1110	5Eh	94	
neo:6m	direct select dts neo:6 music	0101 1111	5Fh	95	
5ch stereo	direct select 5 channel stereo	0100 1110	4Eh	78	
7ch stereo	direct select 7 channel stereo	0100 1111	4Fh	79	
dolby d	direct select dolby digital	0000 1100	0Ch	12	
dolby ex	direct select dolby digital surround ex	0000 1101	0Dh	13	
dts	direct select dts	0000 1111	0Fh	15	
dts-es	direct select dts extended surround	0100 1100	4Ch	76	
am	direct select tuner am frequency band	1100 1001	C9h	201	yes
fm	direct select tuner fm frequency band	1100 1010	CAh	202	yes
preset1	direct select tuner preset 1	0001 1000	18h	24	yes
preset2	direct select tuner preset 2	0001 1001	19h	25	yes
preset3	direct select tuner preset 3	0001 1010	1Ah	26	yes
preset4	direct select tuner preset 4	0001 1011	1Bh	27	yes
preset5	direct select tuner preset 5	0101 1000	58h	88	yes
preset6	direct select tuner preset 6	0101 1001	59h	89	yes
preset7	direct select tuner preset 7	0101 1010	5Ah	90	yes
preset8	direct select tuner preset 8	0101 1011	5Bh	91	yes

Command	GTP-880 Function	IR: D7-D0	Hex	Deci	Turn on
distance +	increase distance to front speakers (affects delay delta)	0000 0000	00h	0	
front distance -	decrease distance to front speakers (affects delay delta)	0000 0001	01h	1	
center distance +	increase distance to center speakers (affects delay delta)	0000 0010	02h	2	
center distance -	decrease distance to center speakers (affects delay delta)	0000 0011	03h	3	
surr rear distance +	increase distance to surround speakers (affects delay delta)	0100 0000	40h	64	
surr rear distance -	decrease distance to surround speakers (affects delay delta)	0100 0001	41h	65	
surr back distance +	increase distance to surround speakers (affects delay delta)	1101 1010	DAh	218	
surr back distance -	decrease distance to surround speakers (affects delay delta)	1101 1011	DBh	219	
sub distance +	increase distance to subwoofer (affects delay delta)	1101 1000	D8h	216	
sub distance -	decrease distance to subwoofer (affects delay delta)	1101 1001	D9h	217	
distance unit	toggles feet/meter	0100 0101	45h	69	
center trim +	adjust center channel level up	0000 1000	08h	8	
center trim -	adjust center channel level down	0000 1001	09h	9	
rear l trim +	adjust rear left channel level up	0000 1010	0Ah	10	
rear l trim -	adjust rear left channel level down	0000 1011	0Bh	11	
rear r trim +	adjust rear right channel level up	0100 1000	48h	72	
rear r trim -	adjust rear right channel level down	0100 1001	49h	73	
sub trim +	adjust subwoofer channel level up	0100 1010	4Ah	74	
sub trim -	adjust subwoofer channel level down	0100 1011	4Bh	75	
back l trim +	adjust back left channel level up	0001 1100	1Ch	28	
back l trim -	adjust back left channel level down	0001 1101	1Dh	29	
back r trim +	adjust back right channel level up	0001 1110	1Eh	30	
back r trim -	adjust back right channel level down	0001 1111	1Fh	31	
d.range 0	direct select dynamic range no comp	1101 0100	D4h	212	
d.range 25	direct select dynamic range comp 25%	0100 0111	47h	71	
d.range 50	direct select dynamic range comp 50%	0100 0110	46h	70	
d.range 75	direct select dynamic range comp 75%	0100 0011	43h	67	
d.range 100	direct select dynamic range comp 100%	0100 0010	42h	66	
room2 dvd	direct select dvd audio for room 2	0001 0001	11h	17	
room2 vcr	direct select vcr audio for room 2	0001 0000	10h	16	
room2 cd	direct select cd audio for room 2	0001 0011	13h	19	
room2 video 1	direct select video 1 audio for room 2	1000 1100	8Ch	140	
room2 video 2	direct select video 2 audio for room 2	1000 1101	8Dh	141	
room2 video 3	direct select video 3 audio for room 2	1000 1110	8Eh	142	
room2 tuner	direct select tuner audio for room 2	0101 0000	50h	80	
room2 tape	direct select tape audio for room 2	0101 0001	51h	81	
room2 aux	direct select aux audio for room 2	0001 0010	12h	18	
7.1m2 on	direct select 7.1m2 processing on	1000 1111	8Fh	143	
7.1m2 off	direct select 7.1m2 processing off	1100 1100	CCh	204	
bass +	adjust bass up	1000 0111	87h	135	
bass -	adjust bass down	1100 0100	C4h	196	
treble +	adjust treble up	1100 0101	C5h	197	
treble -	adjust treble down	1100 0110	C6h	198	
tone reset	resets bass & treble to 0	1100 0111	C7h	199	
stereo	direct select stereo mode	1001 0100	94h	148	
unused	unused	1001 0101	95h	149	
unused	unused	1001 0110	96h	150	
unused	unused	1001 0111	97h	151	
factory defaults	resets all to factory defaults settings	1000 0110	86h	134	

3.1 Setup Overview

At this point you should have made all the necessary physical connections between the GTP-880 and your source equipment, amplifiers and speakers. All that remains is to properly configure the system to reflect your specific equipment and room characteristics.

To turn the GTP-880 on:

1. Plug the cord into an AC wall outlet or UL approved power strip or surge protection device.

Make certain that the AC power cord supplied with the GTP-880 is firmly inserted into the socket on the unit's rear panel.

2. Press the rear panel power switch to the on position to set the GTP-880 to standby mode.

The standby indicator on the front panel will light up.

3. Press the front panel standby power button to turn on the GTP-880 or press the power button on the remote control.

The front panel display will light up and the standby indicator will turn red.

3.2 On Screen Display

Setup of the GTP-880 is performed by using the remote control. Information is shown on the front panel display, or the on screen display (OSD). All selections are made using a combination of the following buttons:



To use the GTP-880 menu system:

1. Press the main menu button to display the main menu. The main menu appears on the OSD:

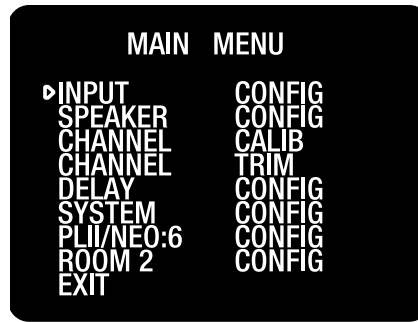

2. Press ▼ or ▲ followed by the select button to select a setup menu. Your selection appears on the OSD:
3. Press ▼ or ▲ to select an item to adjust. Your selection appears on the front panel display and the OSD:
4. Press ◀ or ▶ to select or adjust a setting.

Once you have made your selections, you can use the ▼ and ▲ to return to the main menu and/or exit the menu system. Alternatively, pressing the menu button once will return you to the main menu. Pressing the menu button a second time will exit the menu system. Note that the menus will remain visible on the front panel and OSD until you exit the menu system.

Important Note: When viewing static images such as on screen menus or video game images using a CRT-based projector, plasma display or direct-view CRT monitor or television, there is a risk of permanently “burning in” the image. Do not leave these images on for an extended period of time. This type of damage is not covered by the ADCOM GTP-880 warranty.

3.3 Input Configuration

Before calibrating your GTP-880 and adjusting loudspeaker setup and configuration, you should first set up the sources connected to it. You will make your selections using the input configuration menu, shown below.

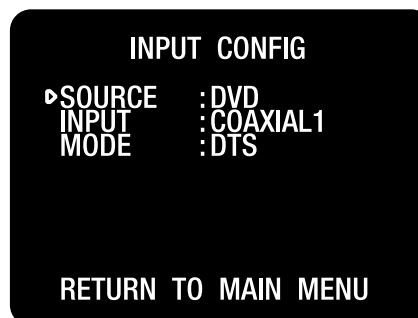

To configure an input:

1. Press the menu button to enter the main menu. The main menu appears on the front panel display and the OSD. The cursor on the OSD should be pointing to the input configuration menu and input config appears on the front panel display.

2. Press select to enter the input configuration menu. The input configuration menu appears on the front panel display and the OSD. The selected menu item should be source.

3. Use the ◀ and ▶ buttons to select which particular Source you wish to configure. The Source choices appear as follows as you scroll through them:

DVD, video1, video2, video3, VCR, tuner FM, tuner AM, CD, TAPE, and AUX

You can scroll in either direction using the < and > buttons.

4. Press the ▼ button once to select the Input menu.

5. Use the ◀ and ▶ buttons to select an Input for that source. The input choices appear as follows as you scroll through them:

ANALOG, OPTICAL 1, OPTICAL 2, OPTICAL 3, COAXIAL 1, COAXIAL 2, COAXIAL 3

You can scroll in either direction using the < and > buttons.

If you connected the source to the Analog inputs, select: analog.

If you connected the source to one of the optical digital inputs, select the appropriate one by choosing: optical 1, optical 2 or optical 3

If you connected the source to one of the coaxial digital inputs, select the appropriate one by choosing: coaxial 1, coaxial 2 or coaxial 3.

Note: Always connect and configure the digital input source option if one is available from the specific component, as this will provide maximum performance and best sound quality.

Remember that you can always return to any menu to change your selection, should that be required.

6. Press the ▼ button once to select the Mode menu.

7. Use the ◀ and ▶ buttons to select a Mode for that source. The available surround modes appear as follows as you scroll through them:

PLII-C, PLII-M, Dolby PL, 7 stereo, 5 stereo, stereo, NEO:6-C, NEO:6-M, Dolby, Dolby EX, DTS, DTS-ES

You can scroll in either direction using the < and > buttons.

You should choose a surround mode to be the default for this source. Remember that all available mode options can be selected for a digital input source, but certain modes will not be available through the analog input for that source.

Selecting the default mode will not exclude other modes of surround decoding. In fact, certain digital signals (Dolby Digital, DTS, some Dolby Digital EX, and others) contain a special digital “flag” that tells the GTP-880 to switch to that surround mode. When the GTP-880 receives one of these bitstreams it will switch to that mode of operation. Additionally, you can manually cycle through the available modes while the source is playing to choose the one you wish to use.

3.4 Speaker Configuration

You are now ready to configure the GTP-880 for your particular loudspeaker system. Before proceeding please read the following information carefully:

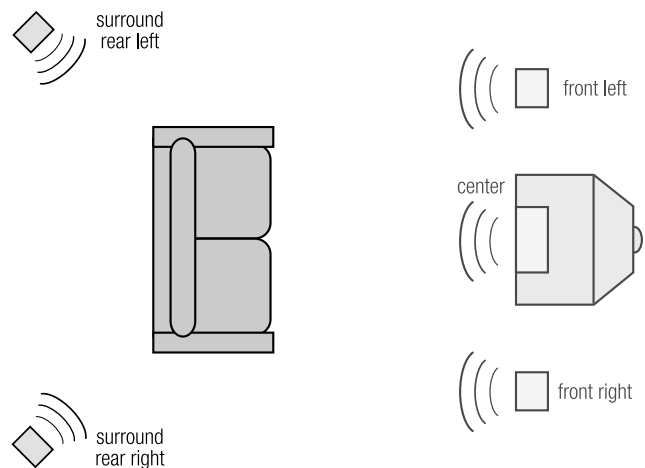

This speaker setting is preferred if you are not using surround backs.

Speaker Placement

The best speaker placement for your particular room will depend on its size, furnishings, seating arrangement, the acoustical properties of the space, including wall type, coverings, and various other factors.

Due to the complex nature of these variables it is impossible to recommend any one-size-fits-all placement. You may well have to experiment with various placement options to determine the best configuration for your

specific situation. Please note that, the configuration and placement of your speakers is critical for creating the best possible surround sound playback.

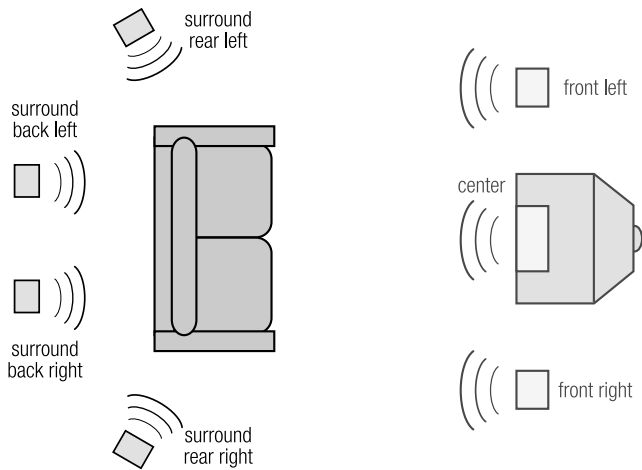

This is the preferred speaker setting if you are using surround backs.

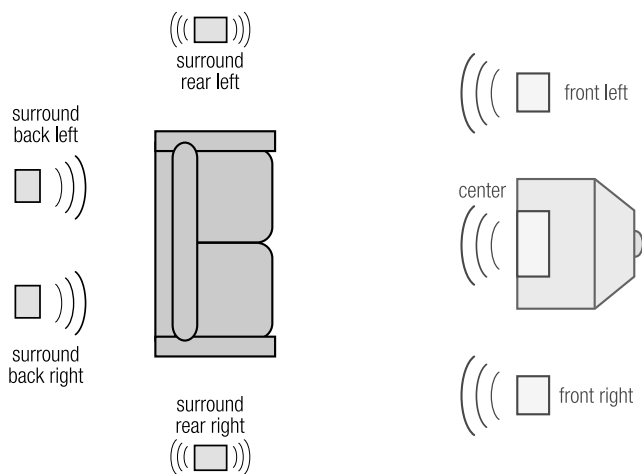

This speaker setting is preferred if you are using dipoles for your surround rears.

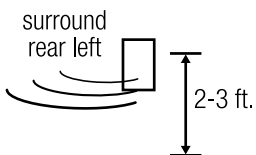

Note: If space permits, install surrounds 2-3 feet above viewers. This helps to minimize localization effects.

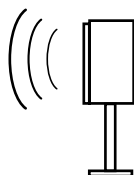
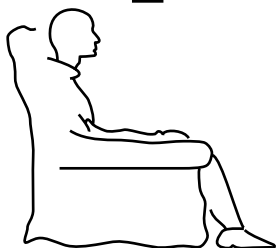

To configure the GTP-880 for your speaker system:

1. Press the menu button to enter the main menu. The main menu appears on the front panel display and the OSD. The cursor on the OSD should be pointing to the input configuration menu and input config appears on the front panel display.
2. Press the ▼ button once to select the speaker configuration menu. The cursor on the OSD should be pointing to the speaker configuration menu and speaker config appears on the front panel display.
3. Press select to enter the speaker configuration menu. The speaker configuration menu appears on the front panel display and the OSD. The selected menu item should be front.



The first three settings in the speaker configuration menu deal with the type of speakers you are using in your system. It is very important that you understand what is meant by the large and small settings in this menu. They do not refer to the physical size of the speakers, but to their ability to handle very powerful deep bass. Most loudspeaker systems on the market should be classified as small, since they do not have the capability to handle the often extraordinary amount of deep bass content film soundtracks can contain.

It is strongly recommended that you consult your loudspeaker instruction manual regarding the capabilities of your particular system with regard to low bass/low frequency reproduction.

In any case you should consider using a subwoofer for any system which you expect to effectively handle the low frequency dynamics of modern motion picture soundtrack sources such as DVD or HDTV feeds, and many other discrete multichannel programming sources.

If you aren't sure about your speaker's real world capabilities and you are using a subwoofer, choose small, since

this will insure that all the appropriate low frequency information is directed to the subwoofer where it can be most effectively handled.

4. Use the ◀ and ▶ buttons to cycle through the speaker options for the front speaker. The following options are available for each group of loudspeakers:

- For front you can select small or large
- For center you can select small, large or none
- For surr(ounds) you can select small, large or none
- For surr(ounds) rear you can select BS(LB), LB/RB or none. LB/RB means you have a left back and right back rear surround speaker setup for use in a 7.1 configuration. BS(LB) means you have a single centrally placed back surround speaker for use in a 6.1 (EX) type configuration.
- For subwoofer you can select on or off

5. Press the ▼ button when you have made a selection. Repeat steps 4 and 5 until you have completed selecting the speaker type for each loudspeaker in your system.

6. Press the ▼ button when you are finished to select the front crossover (xover) menu. The front, center and surround crossover menus are used to independently set the internal high pass filter of the GTP-880's crossover for each of these three speaker groups.

7. Use the ◀ and ▶ buttons to adjust the front crossover. The crossover settings appear as follows as you scroll through them: 40Hz, 60Hz, 80Hz, 100Hz, 120Hz, 150Hz

Note: None will appear for a large speaker setting.

You can scroll in either direction using the ◀ and ▶ buttons.

Consult the material that came with your loudspeakers to determine the correct settings, if any are recommended. If you are not sure about the frequency response of your speakers, we recommend you set the crossover at 80Hz, unless otherwise directed by the manufacturer. If you are using very small satellite speakers you may need to set the crossovers to 100 or even 120Hz. When correctly set, you should hear a smooth transition of lower to upper bass between the satellites and the subwoofer.

8. Press the ▼ button when you have made a selection. Repeat steps 7 and 8 until you have completed the speaker crossover settings for each group of speakers.

9. Press the ▼ button to select the return to main menu option.

10. Press select or menu to return to the main menu, or press the menu button twice to exit the menu system.

3.5 Channel Configuration: Calibration

The next step is to adjust the output level of each channel so that they are properly matched. This must be done to insure a correct presentation of multichannel sound sources. The adjustment must be as precise as possible, and is almost impossible to accomplish by ear. Therefore, we recommend that you use a sound level meter. This device insures that all loudspeaker levels are precisely matched and set accurately. (The Radio Shack analog sound level meter is inexpensive and suitable for this task.)

Set the meter to slow response and "C" weighting. Set it to the 70 or 80dB sensitivity scale. Position the meter at the approximate center of your listening area, at average ear height [approximately 40-46 inches (102-117 cm)] with its microphone positioned vertically (pointing at the ceiling). Don't aim the microphone at the speakers, as this will produce inaccurate results.

To proceed with the adjustments, you will access the channel calibration menu shown below.

To set the channel levels for you system:

With no source playing, set the volume level of the GTP-880, using the main volume control, to 0dB.

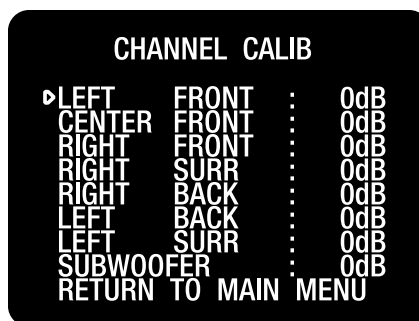

1. Press the menu button to enter the main menu. The main menu appears on the front panel display and the OSD. The cursor on the OSD should be pointing to the input configuration menu and input config appears on the front panel display.

2. Press the ▼ button until the channel calibration menu is selected. The cursor on the OSD should be pointing to the channel calibration menu and channel calib appears on the front panel display.

3. Press select to enter the channel calibration menu. The channel calibration menu appears on the front panel display and the OSD. The selected menu item should be left front.

A special test tone will be generated allowing you to measure the output of the speaker that's playing. Adjust the master volume as needed.

4. Use the ◀ and ▶ buttons to adjust the speaker level. You can adjust the selected channel level in 1dB steps across a range of -15dB to +10dB.

5. Press the ▼ button when you have finished making the left front level adjustment. Repeat steps 5 and 6 until you have completed setting the level for each speaker in your system.

6. When you have finished adjusting the level for all the speakers in your system, press the ▼ button to select the return to main menu option.

7. Press the select or menu button to return to the main menu, or press the menu button twice to exit. You can also perform this calibration at any time by using the built in test tone, by pressing the ch. cal button on the GTP-880 remote control.

To set channel levels using the test tone function:

1. Press the ch. cal button on the remote (make sure to press the main button first). This will produce a display that shows:

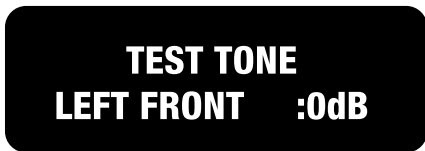

When you select this function, the GTP-880's test tone will automatically cycle every few seconds through all the speakers you have told the GTP-880 are connected to the system. The unit cycles through the speakers in the following sequence:

left front, center front, right front, right surr(ound), right back (surround), left back (surround), left surr(ound), subwoofer

2. Use the ◀ and ▶ buttons to adjust the speaker level. You can adjust the selected channel level in 1dB steps across a range of -15dB to +10dB.

While you are adjusting each speaker, the test tone will remain on that channel until you have stopped changing

the volume for a few seconds. The unit will then resume cycling the test tone from speaker to speaker, until you touch the ch. cal button again.

Note: Speakers that you selected "none" for in the speaker config menu will not appear.

3. Press the ch. cal button on the remote control again to exit the test tone function.

Channel Trim

Channel trim allows you to fine tune the channel levels to compensate for various soundtrack anomalies. For example, you may play a movie and find that the center (dialogue) channel is weak, making the movie hard to follow. Simply trimming the center channel up a dB or two can fix the problem. Or another film may have substantially more bass than normal and trimming the subwoofer channel down a dB or two may help balance the sound correctly.

This function can be accessed in two ways. You can press the ch. trim button on the remote control, or you can access this feature through the main menu. The channel trim menu is shown below.



To adjust channel trim from the main menu:

1. While playing the program material with output that you wish to fine tune, press the menu button to enter the main menu.

The main menu appears on the front panel display and the OSD. The cursor on the OSD should be pointing to the input configuration menu and input config appears on the front panel display.

2. Press the ▼ button until the channel trim menu is selected. The cursor on the OSD should be pointing to the channel trim menu and channel trim appears on the front panel display.

3. Press select to enter the channel trim menu. The channel trim menu appears on the front panel display and

the OSD. The selected menu item should be left front.

4. Use the ◀ and ▶ buttons to adjust the channel trim. You can adjust the selected channel trim level in 1dB steps across a range of -15dB to +10dB.

5. Press the ▼ button when you have finished making the channel trim adjustment. If necessary, repeat steps 4 and 5 until you have completed setting the level for each speaker in your system.

6. Press the ▼ button when you have finished making the channel trim adjustment to all the speakers in your system to select the return to main menu option.

7. Press the select or menu button to return to the main menu, or press the menu button twice to exit.

To adjust channel trim using the trim function:

1. Press the ch. trim button on the front panel or the remote control. The front panel display and the OSD will show the following:



2. Use the ◀ and ▶ buttons to adjust the channel trim level. You can adjust the selected channel level in 1dB steps across a range of -15dB to +10dB.

3. When you are finished adjusting the channel trim for the selected speaker, press trim again to cycle to the next channel. The unit cycles through the speakers in the following sequence:

left front, center front, right front, right surr, right back (surround), left back (surround), left surr, subwoofer

If necessary, repeat steps 2 and 3 until you have adjusted the channel trim of all the speakers in your system.

4. Press the ch. trim button on the remote control again to exit the channel trim function.

Remember to return any channel(s) that you have trimmed back to the original setting when you are done watching the particular program. If you find you are continually trimming the same channel(s) by the same amount for every film, you might want to consider re-calibrating the speaker levels as shown in the section, "channel calibration". Set the levels for the channel(s) up or down by the amount you normally trim them.

3.6 Delay Configuration

Setting the speaker delay is crucial to the proper performance of any surround decoder component like the GTP-880. Your home theater system will not perform properly if this process is not completed.

To accomplish this process you will need a tape measure or other means of determining the distance of each speaker from the primary listening position.

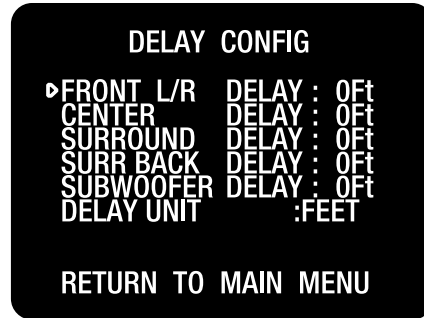

To set the speaker distance delays for your speakers:

1. Press the menu button to enter the main menu. The main menu appears the OSD. The cursor on the OSD should be pointing to the input configuration menu.

2. Press the ▼ button until the delay configuration menu is selected.

3. Press select to enter the delay configuration menu. The delay configuration menu appears on the front panel display and the OSD. The selected menu item should be front L/R delay.

Before setting the speaker distances, you need to choose what unit of distance you will be using.

4. Press the ▼ button repeatedly until the distance unit menu is selected.

5. Use the ◀ and ▶ buttons to select between feet and meters.

6. Press the ▲ button repeatedly until you return to the front distance menu. To set the distance for each group speakers in your system, you will need to measure, the distances from your chosen listening/viewing position to the various loudspeakers in your system.

Set the distance for the front L/R speakers to the nearest foot/meter. Rounding up is OK. Distances can be set in the following increments:

Feet 0 to 20 feet in 1 foot increments.

Meters 0 to 6 meters in 0.3 meter increments.

You can scroll in either direction using the ◀ and ▶ buttons.

7. Press the ▼ button when you have made a selection. Repeat steps 6 and 7 for the center and surround speakers.

NOTE: There is no delay function for the subwoofer

8. Press the ▼ button until the return to main menu option is selected.

9. Press the menu button to return to the main menu, or press the menu button twice to exit.

3.7 System Configuration Setting the Display Brightness

This control sets the front panel display brightness. The default display brightness is set to be easily visible in a normally lit room. If you prefer to dim the display, for example, during movie viewing in a darkened room, you can access the VFD brightness setting from the system configuration menu.

To set the front panel display brightness:

1. Press the menu button to enter the main menu. The



main menu appears on the OSD. The cursor on the OSD should be pointing to the input configuration menu and input config appears on the front panel display.

2. Press the ▼ button until system configuration is selected. The cursor on the OSD should be pointing to the system configuration menu and system config appears on the front panel display.

3. Press the select button to enter the system configuration menu. The system configuration menu appears on the OSD. Display bright is selected.

5. Use the ◀ and ▶ buttons to choose between full and half.

6. After making your selection, exit the main menu. The dim button can also be used on the remote control.

Setting the OSD Time Out

This menu is used to set how long the on screen display will remain visible after a button is pushed or setting is changed on the GTP-880.

To set the on screen display time out:

1. Press the menu button to enter the main menu. The main menu appears on the OSD. The cursor on the OSD should be pointing to the input configuration menu.

2. Press the ▼ button until system configuration is selected. The cursor on the OSD should be pointing to the system configuration menu and system config appears on the front panel display.

3. Press the select button to enter the system configuration menu. The system configuration menu appears on the front panel display and the OSD.

4. Press the ▼ button until the OSD time out menu is selected.

5. Use the < and > buttons to cycle through the available options. The following times appear as you scroll through them: 30 sec, 25 sec, 20 sec, 15 sec, 10 sec, 5 sec, 0 sec

Note: Setting the time out to 0 sec. disables the OSD status.

6. After making your selection, press the ▼ button twice to exit the main menu.

Sleep Timer

This option allows you set how long the unit will remain on before automatically shutting off. This mode can be accessed using the sleep button on the remote control, or from system configuration menu.

To set the sleep timer from the main menu:

1. Press the menu button to enter the main menu. The main menu appears on the front panel display and the OSD. The cursor on the OSD should be pointing to the input configuration menu and input config appears on the display.

2. Press the ▼ button until system configuration is selected. The cursor on the OSD should be pointing to the system configuration menu and system config appears on the front panel display.

3. Press the select button to enter the system configuration menu. The system configuration menu appears on the front panel display and the OSD.

4. Press the ▼ button until the sleep time set menu is selected.

5. Use the ◀ and ▶ buttons to cycle through the available

choices. The following times appear as you scroll through them: 60min, 50min, 40min, 30min, 20min, 10min, 5min, 0min

6. After making your selection, exit the menu.

Theater Compensation

Theater compensation provides special equalization within any of the selected DSP modes. Most theatrical soundtracks are mixed on large dubbing stages for playback in large movie theaters. When these soundtracks are played back in your home, they may appear to have too much treble, sounding harsh and "bright." Theater compensation modifies the audio signal to reduce these characteristics and make the soundtrack reproduction more natural sounding.

Theater compensation can be accessed from the main menu or the th-eq button on the remote control turns theater comp. on/off.

To turn on Theater compensation from the main menu:

1. Press the menu button to enter the main menu. The main menu appears on the front panel display and the OSD. The cursor on the OSD should be pointing to the input configuration menu and input config appears on the front panel display.



DVD DOLBY D
THEATER COMP:ON

2. Press the ▼ button until system configuration is selected. The cursor on the OSD should be pointing to the system configuration menu and system config appears on the front panel display.

3. Press the select button to enter the system configuration menu. The system configuration menu appears on the front panel display and the OSD. The selected menu item should be display bright.

4. Press the ▼ button until the theater comp.

menu is selected.

5. Use the ◀ and ▶ buttons to choose between on and off.

6. After making your selection, press the menu button twice to exit the main menu.

To turn on theater compensation using the th-eq button:

1. Press the th-eq button on the remote control. The front panel display and the OSD will show the following:

2. Press the th-eq button again to toggle the between on and off. The theater compensation menu will disappear automatically approximately five seconds (a factory default, may be changed in OSD time out) after you make your selection.

Dolby Pro Logic II Cinema and DTS-ES NEO:6 Cinema include a form of equalization of their own to address the same conditions. When using these modes the addition of theater compensation may cause excessive reduction of the upper frequencies. However, you may wish to experiment with different soundtracks to find what sounds best to you.

Important Note: Theater compensation is not recommended for music modes, as the equalization added is not normally needed.

Analog Level Input and Peak Indicator

Not all consumer products (CD players, DVD players, etc.) reach a 2V RMS output, therefore the analog input level needs to be adjusted to meet such requirement before being processed. Adjustments are made in 1dB steps from -15dB to +10dB and do not affect any of the analog direct inputs.

Should the input signal overload the analog to digital convertor, the word "peak" will start flashing after "anlg peak ind:" until the user turns down the input signal via the master volume knob or left/right selector (when in the system config menu).

3.8 Pro Logic II and NEO:6 Music Config

The PLII Music parameter menu is used to adjust the panorama, dimension and center Width processing options when listening to music in the Dolby Pro Logic II surround mode. For a description of these options, see the section titled "surround format information." The PLII parameter menu is shown on the following page.

To adjust the PLII Music Parameters:

1. Press the menu button to enter the main menu. The main menu appears on the OSD. The cursor on the OSD should be pointing to the input configuration menu and input config appears on the front panel display.

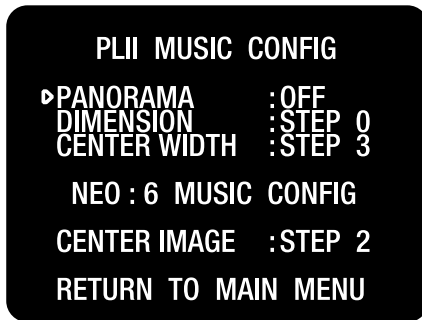

2. Press the ▼ button until the PLII music parameter menu is selected. The cursor on the OSD should be pointing to the PLII music parameter menu and PLII music parameter appears on the front panel display.

3. Press select to enter the PLII music parameter menu. The PLII music parameter menu appears on the front panel display and the OSD. The selected menu item should be panorama.

4. Use the ◀ and ▶ buttons to select between on and off. When this setting is on, Pro Logic II's panorama circuits will blend an amount of the front channel information into the side speakers so that the sound field appears to wrap around the front and sides of the soundstage. Experiment with a variety of program sources to see if this effect is one you prefer.

5. Press the ▼ button to select the dimension menu.

6. Use the ◀ and ▶ buttons to cycle through the dimension options. The dimension settings appear as follows as you scroll through them:

step 0, step 1, step 2, step 3, step-3, step-2, step-1

You can scroll in either direction using the ◀ and ▶ buttons.

The dimension control uses special circuitry to give the impression that the "center" of the sound field is moving towards the front or rear of the room. Experiment with a variety of program sources to see if this effect is one you prefer. Use as much or as little dimension as you feel is needed.

7. Press the ▼ button to select the C width menu.

8. Use the ◀ and ▶ buttons to cycle through the C width options. The C width settings appear as follows as you

scroll through them:

step 0, step 1, step 2, step 3, step 4, step 5, step 6, step 7

You can scroll in either direction using the ◀ and ▶ buttons.

Depending on how the center width control is set, you may adjust the apparent placement of the center channel image so that it is heard only from the center speaker, so that it is blended into the left and right speakers as a phantom image, or that it is blended among the front left, center and right speakers in varying amounts. As with the other Pro Logic II controls, the use of this setting and the degree to which it is used is a matter of personal preference.

9. Center image can also be adjusted.

10. Press the menu button to return to the main menu, or press the menu button twice to exit.

3.9 Room Two Configuration

This menu controls the setting for your second room and the output from the room 2 out jacks on the rear of the GTP-880.

This function can be accessed in three ways. You can press the rm.2 button on the remote control, you can access this feature through the Main menu, or from the front panel (please refer to the front panel interface overview section in this manual for details). The room two menu is shown below.

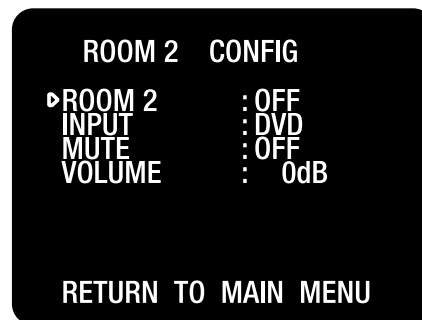

To adjust the room two settings:

1. Press the menu button to enter the main menu. The main menu appears on the OSD. The cursor on the OSD should be pointing to the input configuration menu.

2. Press the ▼ button until the room two menu is selected. The cursor on the OSD should be pointing to the room two menu and room two appears.

3. Press select to enter the room two menu. The room two menu appears on the front panel display and the OSD. The selected menu item should be room two.

4. Use the ◀ and ▶ buttons to select whether you want

the room two feature on or off. If on is selected, the red LED below the word room 2 on/off on the front panel will illuminate indicating activation of the second stereo room.

5. Press the ▼ button to select the Input menu.
6. Use the ◀ and ▶ buttons to select a stereo analog source which signal will be sent through the room 2 outputs to the second room. The source choices appear as follows as you scroll through them:

DVD, video 1, video 2, video 3, VCR, tuner FM, tuner AM, CD, TAPE, AUX

Note: Stereo analog connections must be made from each source except tuner.

You can scroll in either direction using the < and > buttons.

7. Press the ▼ button to select the mute menu.
8. Use the ◀ and ▶ buttons to select whether the room two mute function is on or off.
9. Press the ▼ button to select the volume menu.
10. Use the ◀ and ▶ buttons to increase or decrease the volume level of the signal being sent to the second room. The range available is from -80dB to 10dB. Use caution as you can set a very high volume level and not be aware of it because of the distance between you and the second room.
11. Press the ▼ button to select the return to main menu option.
12. Press the select or menu button to return to the main menu, or press the menu button twice to exit.

3.10 Additional Options Surround Data Format Lock

The GTP-880 will automatically set the surround format based on the signal it receives from the selected source. To avoid the slight delay occasionally encountered in the auto select process, you can choose to override the auto data format detection circuitry by following the procedure below.



DVD DOLBY D
OPTICAL1 00dB

To lock a specific surround mode:

1. Press the desired surround mode button (Dolby, DTS, or stereo) on the remote control repeatedly to cycle through the available processing options. Your selection will appear on the front panel display and OSD.



DVD DOLBY D
DATA FORMAT: AUTO

2. Press the same button for five (5) seconds to choose from among three data format options for digital audio sources. The following is shown on the front panel display and the OSD:

Auto is the default setting for this option, and means that when the unit detects the special code imbedded within certain data streams such as Dolby Digital or DTS it will set itself to properly decode that type of incoming signal.

3. Use the ◀ and ▶ buttons to select one of the data format options. You can select either Dolby D(igital), DTS, or PCM (for Pro Logic II), as the default format. If you do this, signals that are not in the selected format won't be recognized. Therefore, we recommend that you leave the system in auto mode unless you wish to use the selected mode exclusively.

The data format menu will disappear automatically approximately 10 seconds after you make your selection.

Dynamic Range

Dynamic range is a special feature of Dolby Digital that compensates for difficult listening situations by compressing the dynamic range of the speaker output. An example would be when you are watching a movie with a soundtrack that contains very loud passages and you don't want to disturb others in the house.

Both low-level boost and high-level cut compression integrated into night mode compensation is only available when the surround mode of the selected input source is set to Dolby Digital or Dolby Digital EX and downmixing is not enabled (i.e. if the source is a 3/2.1 AC-3 stream, the system must be configured to have at least a 5.0 speaker setup, or greater). When the system is downmixing a multichannel AC-3 stream and Night mode compression is enabled, the low-level signals may still be boosted, however the high-level signals will not be compressed.

To enable/disable Night Mode compensation:

1. Press the d.range button on the remote control. The night mode selection appears on the front panel display and OSD under the currently selected input source.
2. Use the ◀ and ▶ buttons to change the night mode

setting. The unit cycles through the options in the following sequence:

no comp, dr comp1, dr comp2, dr comp 3, dr comp4



The night mode menu will disappear automatically approximately 5 seconds (a factory default, may be changed in OSD time out) after you make your selection.

There are two types of automatic compression control built into the Dolby Digital process. Compression makes the loud parts softer and the soft parts louder to reduce the difference between the two.

One type of compression is most useful for situations such as late night viewing of programs with a wide dynamic range (like many action movies) that might disturb others in your home. This function can also be used to provide compression for program material that may require enhancement of overall intelligibility (such as some older soundtracks).

Another feature provided by this option is the necessary peak limiting required to avoid signal overload when "downmixing" functions are selected.

The second variable provides additional peak limiting to allow overall average program level to be increased by adding even more compression to the signal.

These two algorithms can provide sufficient overall gain reduction to allow even wide dynamic range soundtracks with very soft parts and very loud parts to maintain good audibility at low volume levels.

In most cases a minimum amount of dynamic range reduction is automatically included in the bitstream to ensure safe downmixing. However, regardless if the user chooses to engage Night mode compression or not, the DSP automatically ensures safe downmixing regardless of the signal encoding.

Use the ◀ and ▶ buttons to select a dynamic range option you prefer for the Night setting.

no comp: This option leaves the compression at 0% change.

dr comp1: This option increases the compression by 25%.

dr comp2: This option increases the compression by 50%.

dr comp3: This option increases the compression by 75%.

dr comp4: This option increases the compression by 100%.

Each option increases the amount of Dynamic Range compression to the signal. Depending on your family, neighbors, circumstances, and the overall volume you wish to achieve, we recommend you start with DR COMP1 or DR COMP2 as your initial setting. You will have to experiment with program material and your personal preferences to determine what is acceptable and best for you.

Press the ▼ button to select the return to main menu option.

Press the select or menu button to return to the main menu, or press the menu button twice to exit the menu system.

Installer's Notes

This page has been intentionally left blank.

Resolving Problems

Use the chart on the opposite page to solve common situations that don't require professional attention. If the steps stated in possible solution do not resolve your problem, then please contact your ADCOM dealer or call the ADCOM customer service department. Any problems not covered here should be brought to the attention of your ADCOM dealer or ADCOM customer service dept.

A special note on "hum:" When there is a low-volume "hum" audible throughout your speakers, even with the main volume turned all the way down, you have a common phenomenon known as a "ground loop." A ground loop is basically a difference in ground voltages between two or more components which are connected electrically and which creates multiple current paths where there must only be one. This difference in potentials creates a 60Hz low-level sound (approximately a low A), that seems to "hum."

It can be caused by adding new components to your system, but that does not imply there is anything electrically wrong with any new component. With the advent of audio/video and home theater systems, the problem has become commonplace. Generally, the cause is the Cable-TV incoming signal line. This new incoming line may add an additional ground at a different potential to the AC line ground of your other equipment (refer to note 1 and 2, to troubleshoot a hum problem).

Note 1: Cable TV systems can sometimes contribute to ground loop problems which cause "hum." To determine if your cable system is the contributing factor, disconnect the Cable-TV incoming signal line (round, 75Ω) at the wall, or the first component the cable is connected to (i.e. the cable box, or VCR). If the hum is no longer present, you must insert a "75Ω ground loop isolator" before reconnecting the line. You should check with your ADCOM dealer to obtain one. If the "75Ω ground loop isolator" works only partially or not at all, then please read note 2 to complete the troubleshooting procedure.

Note 2: Make sure that the power amplifier is at least 6" from the GTP-880. Usually putting another component between them is sufficient to minimize the hum. If this does not reduce the hum, turn the system off and disconnect all Inputs from the amplifier. If the hum still persists, then your dealer or service center must examine

the amplifier. If the hum disappears, try another set of RCA cables. Connect one RCA cable at a time to see if one specific cable is responsible. If any or all cables cause the hum to appear, then the preamp or processor should be evaluated for proper operation by your dealer or authorized service center.

System Reset

In rare cases the GTP-880 internal processor may freeze or lock-up causing abnormal operation. This is common to all micro-processor controlled devices when the unit is subject to excessive static discharge, AC line noise, or power spikes.

In most cases it is easy to solve this problem by simply unplugging the GTP-880 from its AC power source for about five minutes. After waiting, reconnect the power cord and turn the unit on. If the unit functions normally, no further action is needed.

In the event that the unit still does not operate properly, it may be necessary to manually reset the processor. Note, however, that when the processor is reset you will lose all settings including digital audio assignments, surround mode settings, speaker configurations, tuner presets and any other memory items. For this reason we strongly recommend that you record these settings so that it is easy to restore them after resetting the processor.

To reset the unit to factory default settings you will need to enter the discrete remote control command. Please refer back to the discrete remote control commands table. The command name is "Factory Defaults", the IR code is 86h. This should reset the system.

If the manual reset does not solve the problem, contact your authorized ADCOM dealer, an authorized ADCOM service center or contact ADCOM's service department directly for further advice.

Symptom	Possible Reason	Possible Solution
No sound	<ul style="list-style-type: none"> • Power AC lead unplugged or power not switched on • Tape Monitor selected • Mute on • Power Amplifier not on 	<ul style="list-style-type: none"> • Check if AC lead is plugged in and power switched on • De-select Tape Monitor mode • Switch off Mute • Turn on the Power Amplifier
No sound on one channel	<ul style="list-style-type: none"> • Speaker not properly connected or damaged. • Input lead disconnected or damaged • In Setup "OFF" for surround speaker selected 	<ul style="list-style-type: none"> • Check connections and speakers • Check leads and connections • Select appropriate Surround mode (large or small)
No sound on surround channels	<ul style="list-style-type: none"> • No surround mode selected • Mono sound source • Speakers not properly connected • Surround volume level too low 	<ul style="list-style-type: none"> • Select a Surround Mode • Test system with stereo or Dolby Surround material • Check speakers and connections • Increase surround volume level
No sound on center channel	<ul style="list-style-type: none"> • In Setup "OFF" for center speaker selected • Speaker not connected properly • Center volume level set too low 	<ul style="list-style-type: none"> • Select appropriate Center mode (large or small) • Check speaker and connection • Increase center volume level
"Dolby Digital" OR "DTS" auto-detection function does not work	<ul style="list-style-type: none"> • Source not connected using digital input • Bit Stream is PCM 	<ul style="list-style-type: none"> • Connect digital output of source to GTP-880 • Check source material
Weak bass/diffuse stereo image	<ul style="list-style-type: none"> • Speakers wired out of phase 	<ul style="list-style-type: none"> • Check connections to all speakers in the system
Remote control handset not working	<ul style="list-style-type: none"> • Batteries dead, or incorrectly inserted • IR transmitter or receiver windows obstructed • IR receiver in direct sun or very bright ambient light 	<ul style="list-style-type: none"> • Check or replace batteries • Remove obstruction • Place unit away from direct sun, reduce amount of ambient light
No sound with tuner	<ul style="list-style-type: none"> • Antenna leads incorrectly connected • Station not selected or weak signal with FM Mute on. 	<ul style="list-style-type: none"> • Check antenna connections to preamplifier • Re-tune or switch off FM Mute
Noise, hiss on AM and FM	<ul style="list-style-type: none"> • Weak signal 	<ul style="list-style-type: none"> • Check station tuning. Adjust or replace antenna.
Distortion on FM	<ul style="list-style-type: none"> • Multi-path signals or interference from another station 	<ul style="list-style-type: none"> • Check station tuning. Adjust or replace antenna
Whistles or buzzes on FM & AM	<ul style="list-style-type: none"> • Interference from other electrical sources - computers, games consoles 	<ul style="list-style-type: none"> • Check station tuning. Switch off or move the source of the electrical noise
Whistles or buzzes on AM	<ul style="list-style-type: none"> • Interference from fluorescent lighting or electrical motor 	<ul style="list-style-type: none"> • Check station tuning. Adjust or replace AM antenna
No RDS name (PS)	<ul style="list-style-type: none"> • Station signal too weak. • Station not transmitting RDS data 	<ul style="list-style-type: none"> • Check station tuning. Adjust or replace antenna • No remedy

Caring for your GTP-880

Great care has been taken by ADCOM to ensure that your amplifier is as flawless in appearance as it is electronically. The front panel is a heavy-gauge, high-grade aluminum extrusion carefully finished and anodized for durability. The chassis, top cover and rear panel are heavy-gauge steel that has been powder coated and baked to ensure a lasting finish. If the front panel, top or sides become dusty or fingerprinted, they can be cleaned with a soft lint-free cloth, slightly dampened with a very mild detergent solution or glass cleaner.

If you will not be using your home theater system for an extended period of time, it is always a good idea to turn the unit off using the power switch on the rear panel of the GTP-880. This will prevent the automatic turn on circuits from accidentally turning the system on during your absence.

DO NOT SPRAY OR POUR LIQUIDS OF ANY KIND DIRECTLY ONTO THE GTP-880.

Servicing

ADCOM has a technical service department to answer questions pertinent to the installation and operation of your unit. In the event of difficulty, please contact us for prompt advice. If your problem cannot be resolved through our combined efforts, we may refer you to an authorized repair agency, or authorize return of the unit to our factory. To aid us in directing you to a convenient service center, it would be helpful if you indicate which major city is accessible to your home.

Please address mail inquires to:

ADCOM Service
8551 East Anderson Drive, Suite 105
Scottsdale, Arizona 85255 USA

Phone, Fax or Email inquires to:

Voice: (480) 607-2277
Fax: (480) 348-9876
Monday through Friday
9:00 AM to 5:00 PM MST
Email: service@adcom.com

For fax inquires, please include a return fax number for the reply. When calling or writing about your ADCOM product, be sure to note and refer to its serial number as well as the date of purchase and the dealer from whom it was purchased. In any communications to us, please include a daytime phone number where we may reach you. In the event the unit must be returned to our factory for service, you will be instructed on the proper procedure when you call or write for a return authorization. **Under no circumstances should your unit be shipped to our factory without prior authorization, or packed in other than its original carton and fillers.**

If the original shipping carton and its fillers have been lost, discarded, or damaged, a duplicate carton may be obtained from our service department for a nominal charge.

Always ship prepaid via United Parcel Service (UPS) or other approved carrier. Do not ship via parcel post, since the packing was not designed to withstand rough parcel post handling.

**FREIGHT COLLECT SHIPMENTS WILL NOT BE ACCEPTED
UNDER ANY CIRCUMSTANCES.**

GTP-880 Specification

Preamplifier Analog Section

Input Impedance	26K Ω
Output Impedance (Main-RCA)	<600 Ω
Rated Input	1.0Vrms
Maximum Input	7.0Vrms
Rated Output (100k Ω load)	2.0Vrms
Minimum Load	5k Ω
Maximum Output	9.5Vrms

Volume Range

Main	-80dB to +10.0 dB (1dB res)
Zone	-80dB to +10.0 dB (1dB res)

Bass Management

High-Pass Slope	Crossover Frequency
(Small Speaker Setting)	12 dB/octave (2nd order)
	(Adj. 40/60/80/100/120/150Hz)
Low-Pass Slope (Subwoofer)	24 dB/octave (4th order), 40-150Hz as above

Tone Control

Bass Center Frequency/Range	100Hz / \pm 8dB
Treble Center Frequency/Range	10kHz / \pm 8dB

Channel Separation (at 1kHz) 80dB

Crosstalk Between Inputs (at 1kHz) 85dB

Preamplifier Digital Section

Frequency Response

Direct Inputs	10 Hz to 20 kHz +0 / -0.2 dB
Analog-DSP Inputs	10 Hz to 20 kHz +0 / -0.5 dB
Digital Inputs	10 Hz to 20 kHz +0 / -0.4 dB

THD+N (at Rated Input & Output)

6-Channel Direct Inputs	0.0035% (80 kHz BW)
Analog-Direct Inputs	0.0035% (AES17 filter)
Analog-DSP Inputs	0.005% (AES17 filter)
Digital Inputs	0.0025% (80 kHz BW)

IMD (CCIF) @ 15 kHz & 16 kHz

6-Channel S/E Inputs	0.003%
All Other Analog Inputs	0.002%
Digital Inputs	0.005%

S/N Ratio (ref. 2.0Vrms A-weighted)

All Direct Inputs	98dB
Analog-DSP Inputs	93dB
Digital Inputs	100dB

FM Tuner Section

Sensitivity

IHF	10dB μ typ.
50dB S/N	13dB μ typ.

S/N Ratio

Mono	72dB typ.
Stereo	60dB typ.

Distortion

Mono	0.3% typ.
Stereo	0.5% typ.

Stereo Separation 40dB typ.

Adjacent Channel Selectivity 50dB \pm 400kHz

Frequency Response 20 Hz to 15 kHz \pm 1dB

AM Tuner Section

Sensitivity (20dB S/N) 400 μ V

S/N 50dB

Distortion 0.7%

One Signal Selectivity (\pm 10kHz) 35 dB

Video Section

Bandwidth

Composite & s-video	6 MHz -3dB
Component Green	100MHz -3dB
Component Red	100MHz -3dB
Component Blue	100MHz -3dB

All video inputs and outputs are 75 ohms, 1.5 Vp-p. Component inputs and outputs work with any Standard requiring ultra-wide bandwidth including Component-RGB, HDTV, line doublers, quadruplers, and scalars.

General

Supply Voltage 105-130V, 60Hz only

Power Consumption 45W

Fuse Rating 1.0A slow-blow 5x20 mm,
2.0A slow-blow 5x20mm

Dimensions

Width	17 inches / 431.8 mm
Height	5.75 inches / 146 mm
Depth	16 inches / 406.4 mm

Weight 28 lbs. / 12.7 kg

Trigger Outputs 1, 2 (Zone) Sequential Delay
50 mA @ 12 VDC

Specifications are subject to change without notice.

ADCOM

A division of Klein Technology Group, LLC
8551 East Anderson Drive, Suite 105
Scottsdale, Arizona 85255
Voice: (480) 607-2277
Fax: (480) 348-9876
<http://www.adcom.com>